

# 1997 Vulcan 1500 Classic PARTS DIAGRAM

Camshaft(s)/Tensioner

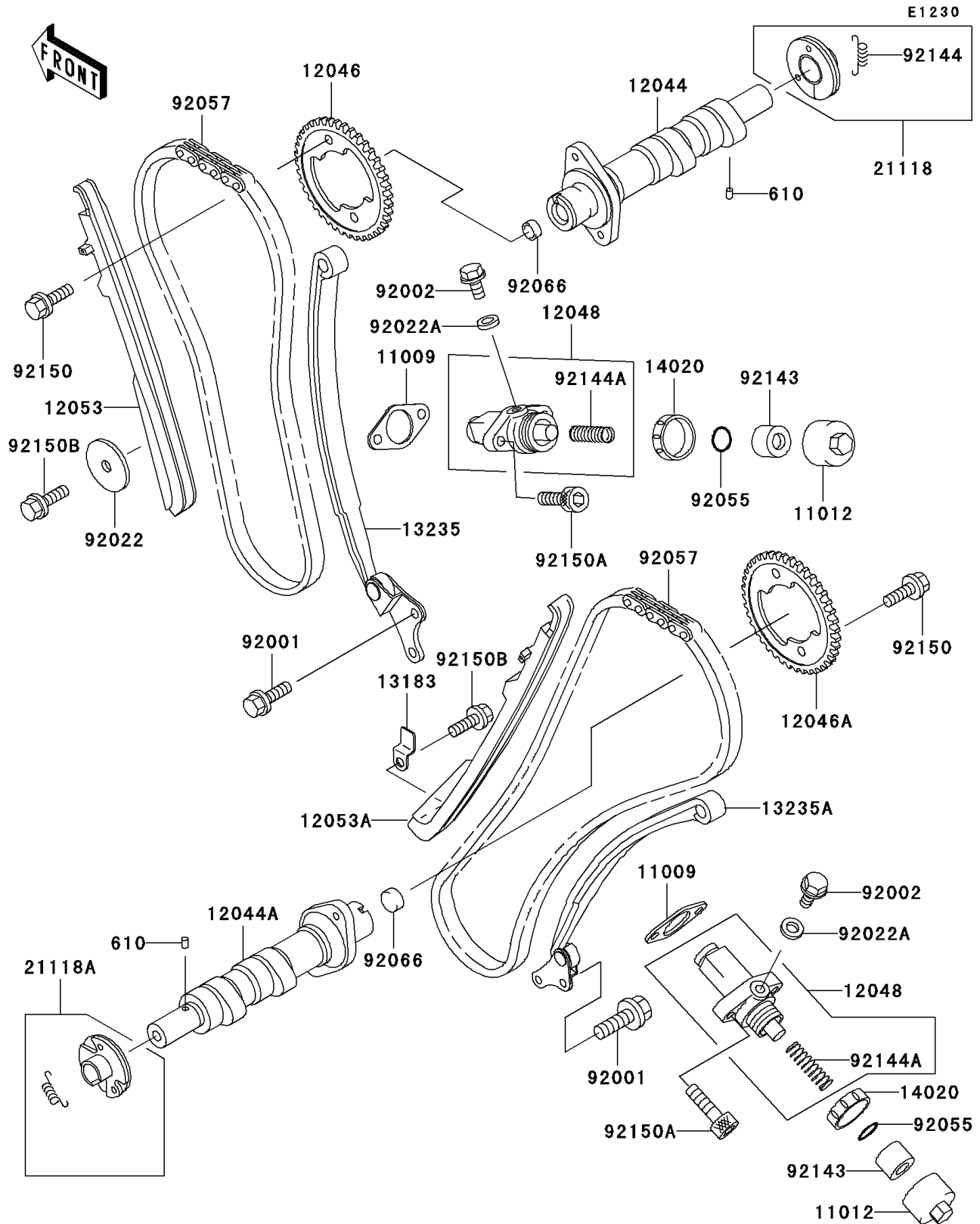

# 1997 Vulcan 1500 Classic PARTS LIST

Camshaft(s)/Tensioner

ITEM NAME	PART NUMBER	QUANTITY
ROLLER,4X6 (Ref # 610)	610A0406	2
GASKET,TENSIONER (Ref # 11009)	11009-1858	2
CAP,TENSIONER (Ref # 11012)	11012-1959	2
CAMSHAFT-VALVE,FR (Ref # 12044)	12044-1394	1
CAMSHAFT-VALVE,RR (Ref # 12044A)	12044-1395	1
SPROCKET,CAMSHAFT,FR,46T (Ref # 12046)	12046-1175	1
SPROCKET,CAMSHAFT,RR,46T (Ref # 12046A)	12046-1176	1
TENSIONER-ASSY (Ref # 12048)	12048-1160	2
GUIDE-CHAIN,FR,TENSIONER (Ref # 12053)	12053-1219	1
GUIDE-CHAIN,RR,TENSIONER (Ref # 12053A)	12053-1221	1
PLATE (Ref # 13183)	13183-1096	1
GUIDE-COMP,FR (Ref # 13235)	13235-1070	1
GUIDE-COMP,RR (Ref # 13235A)	13235-1071	1
RETAINER,TENSIONER (Ref # 14020)	14020-1054	2
DECOMPRESSOR,FR (Ref # 21118)	21118-1061	1
DECOMPRESSOR,RR (Ref # 21118A)	21118-1083	1
BOLT,6X16 (Ref # 92001)	92001-1457	4
BOLT,CLUTCH RELEASE (Ref # 92002)	92002-1356	2
WASHER,7X27X1.6 (Ref # 92022)	92022-227	1
WASHER,6.2X11X1 (Ref # 92022A)	92022-304	2
RING-O,TENSIONER (Ref # 92055)	92055-1555	2
CHAIN,CAM,92RH2010 (Ref # 92057)	92057-1422	2
PLUG (Ref # 92066)	92066-1198	2
COLLAR,TENSIONER (Ref # 92143)	92143-1836	2
SPRING,DECOMPRESSOR (Ref # 92144)	92144-1209	1
SPRING,TENSIONER (Ref # 92144A)	92144-1921	2
BOLT,FLANGED,6X11 (Ref # 92150)	92150-1725	4
BOLT,SOCKET,6X20 (Ref # 92150A)	92150-1795	4
BOLT,6X12 (Ref # 92150B)	92150-1868	2