

2022 MULE SX™ PARTS DIAGRAM

Cooling

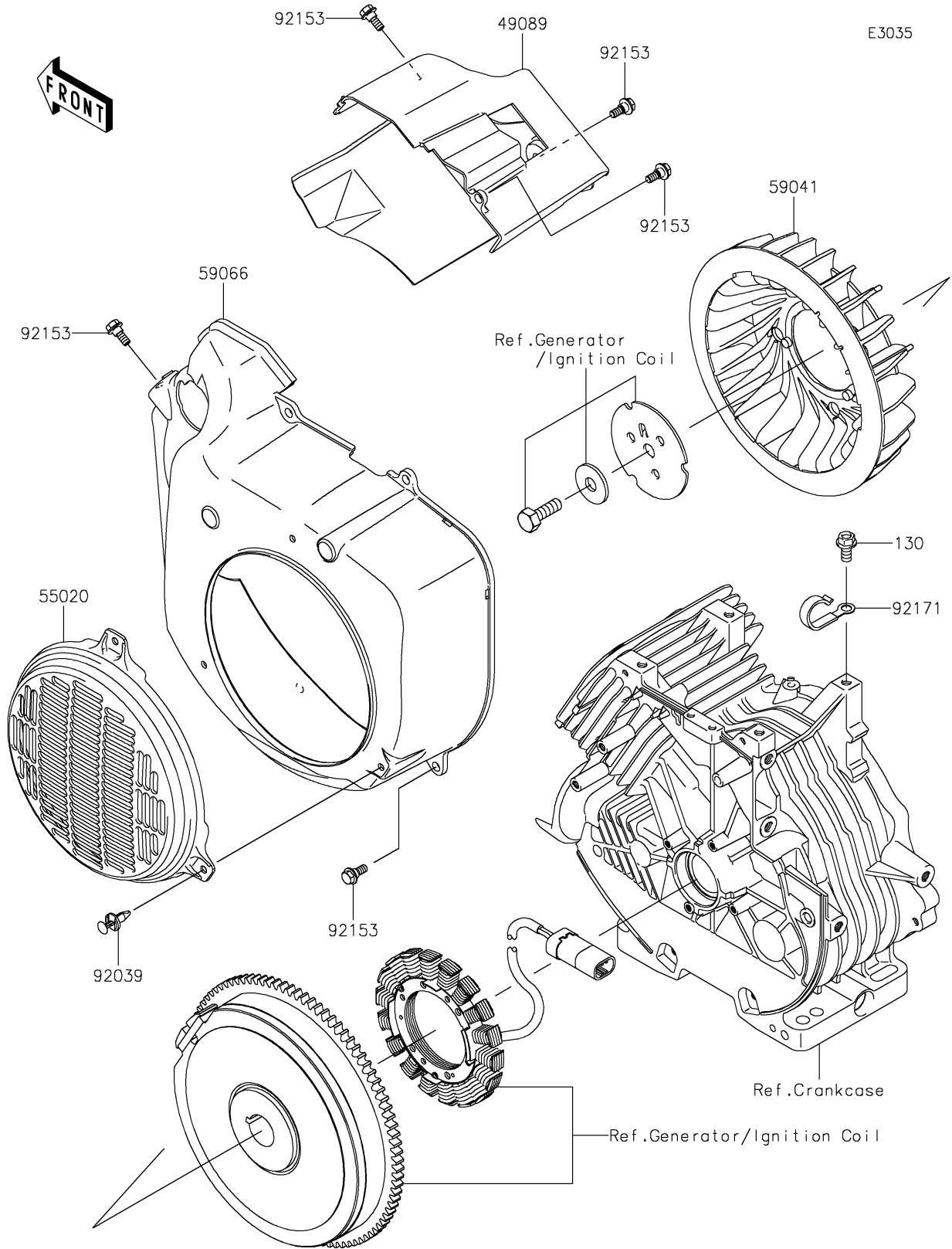

2022 MULE SX™ PARTS LIST

Cooling

ITEM NAME	PART NUMBER	QUANTITY
SHROUD-ENGINE (Ref # 49089)	49089-7089	1
GUARD (Ref # 55020)	55020-2267	1
FAN (Ref # 59041)	59041-0020	1
HOUSING-FAN (Ref # 59066)	59066-0825	1
RIVET,GUARD (Ref # 92039)	92039-0751	3
BOLT,FLANGED,6X16 (Ref # 92153)	92153-7007	8
CLAMP (Ref # 92171)	92171-7005	1
BOLT-FLANGED,8X16 (Ref # 130)	130BA0816	1