

1989 Vulcan 88 SE PARTS DIAGRAM

Front Brake

F2292-0106

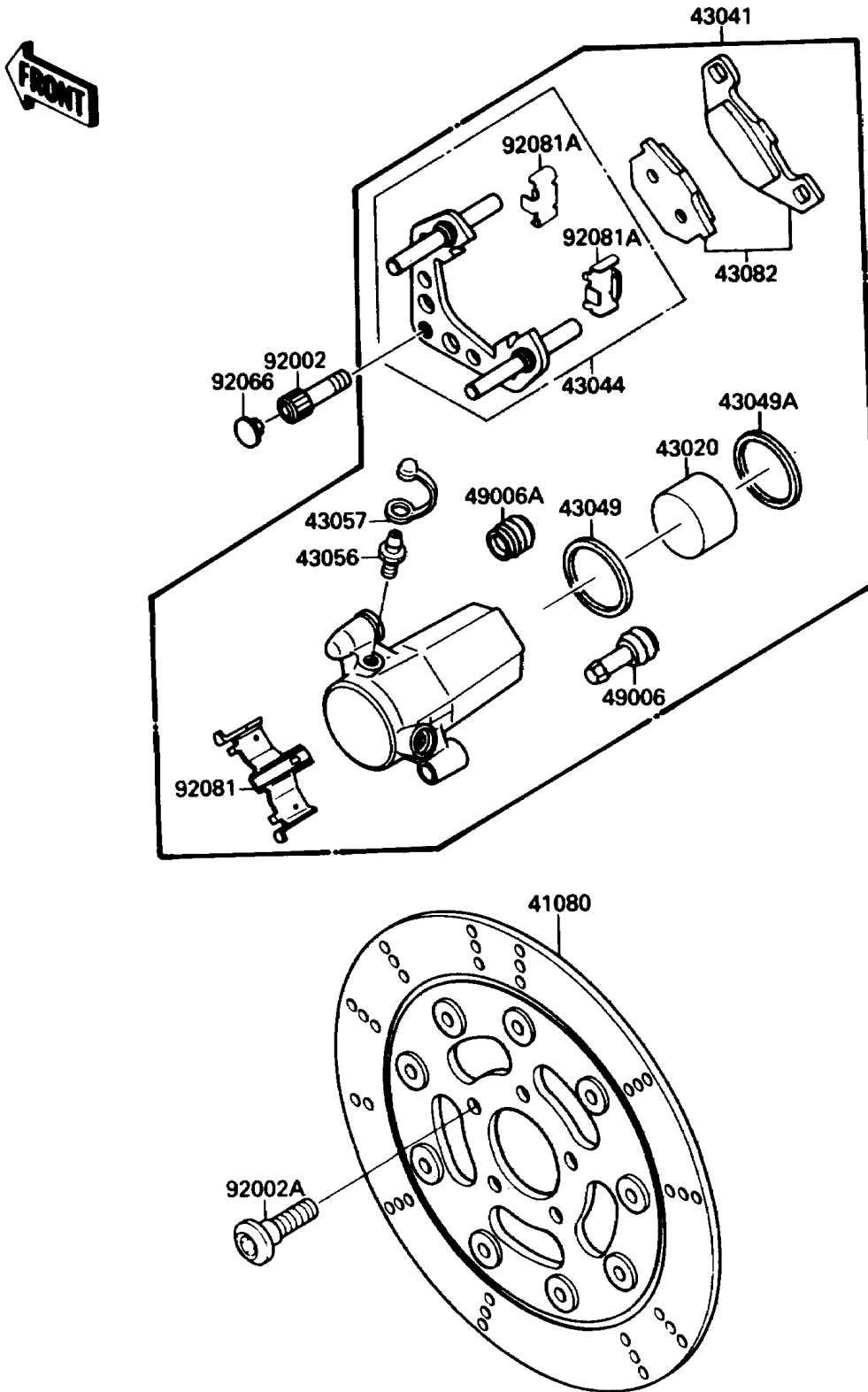

1989 Vulcan 88 SE PARTS LIST

Front Brake

ITEM NAME	PART NUMBER	QUANTITY
DISC,FR (Ref # 41080)	41080-1199	1
PISTON-COMP-BRAKE (Ref # 43020)	43020-1051	1
CALIPER-ASSY,FR,LH (Ref # 43041)	43041-1247	1
HOLDER-COMP-CALIPER,FR,LH (Ref # 43044)	43044-1078	1
RING,PISTON SEAL (Ref # 43049)	43049-002	1
PACKING,PISTON (Ref # 43049A)	43049-1028	1
BREATHER (Ref # 43056)	43056-003	1
CAP-BREATHER (Ref # 43057)	43057-003	1
PAD-ASSY-BRAKE (Ref # 43082)	43082-1080	1
BOOT,CALIPER (Ref # 49006)	49006-1094	1
BOOT,CALIPER (Ref # 49006A)	49006-1095	1
BOLT,SOCKET,10X33 (Ref # 92002)	92001-1901	2
BOLT,SOCKET,8X20 (Ref # 92002A)	92002-1953	5
PLUG (Ref # 92066)	92066-1285	2
SPRING,PAD (Ref # 92081)	92081-1525	1
SPRING,PAD STOPPER (Ref # 92081A)	92081-1661	2