

1996 Vulcan 1500 PARTS DIAGRAM

Front Fork

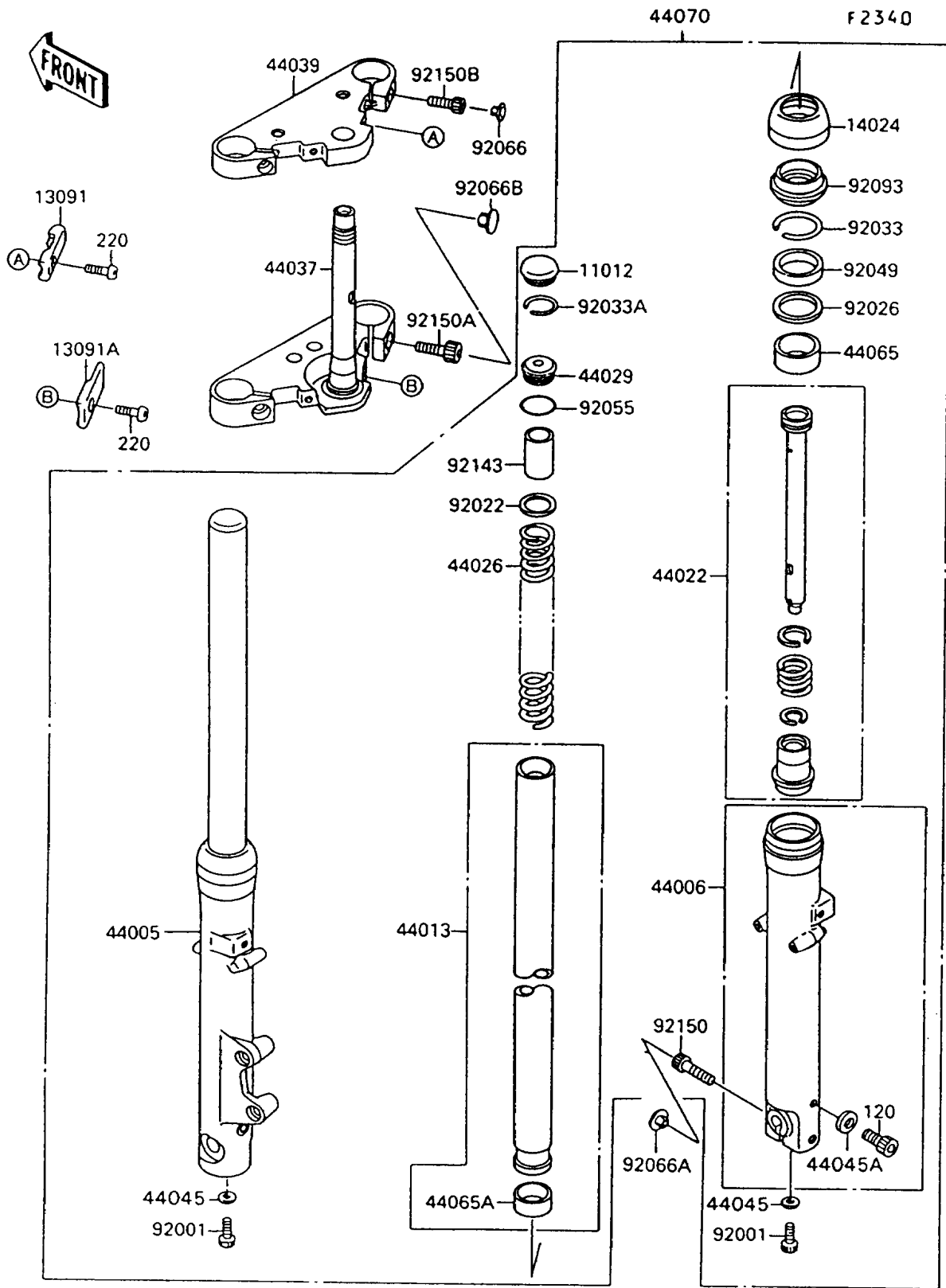

1996 Vulcan 1500 PARTS LIST

Front Fork

ITEM NAME	PART NUMBER	QUANTITY
BOLT-SOCKET (Ref # 120)	120P0608	2
SCREW-PAN-CROS,6X20 (Ref # 220)	220E0620	4
CAP,FORK TOP (Ref # 11012)	11012-1618	2
HOLDER,UPP (Ref # 13091)	13091-1482	2
HOLDER,LWR (Ref # 13091A)	13091-1483	2
COVER,FORK OUTER TUBE (Ref # 14024)	14024-1600	2
PIPE-LEFT FORK OUTER (Ref # 44005)	44005-1264	1
PIPE-RIGHT FORK OUTER (Ref # 44006)	44006-1261	1
PIPE-FORK INNER (Ref # 44013)	44013-1268	2
CYLINDER-FORK (Ref # 44022)	44022-1215	2
SPRING-FRONT FORK (Ref # 44026)	44026-1372	2
SEAT-FORK SPRING (Ref # 44029)	44029-1125	2
HOLDER-FORK UNDER (Ref # 44037)	44037-1235	1
HOLDER-FORK UPPER (Ref # 44039)	44039-1151	1
GASKET,FORK CYLINDER BOLT (Ref # 44045)	44045-051	2
GASKET,DRAIN PLUG (Ref # 44045A)	44045-052	2
BUSHING-FRONT FORK (Ref # 44065)	44065-1079	2
BUSHING-FRONT FORK,INNER PIPE (Ref # 44065A)	44065-1080	2
DAMPER-ASSY,FORK (Ref # 44070)	44070-5038	1
BOLT,FORK CYLINDER (Ref # 92001)	92001-1464	2
WASHER (Ref # 92022)	92022-1909	2
SPACER,FORK OUTER (Ref # 92026)	92026-1276	2
RING-SNAP,FORK OUTER (Ref # 92033)	92033-1222	2
RING-SNAP,SPRING SEAT (Ref # 92033A)	92033-1223	2
SEAL-OIL,FORK (Ref # 92049)	92049-1363	2
RING-O,SPRING SEAT (Ref # 92055)	92055-1363	2
PLUG (Ref # 92066)	92066-1277	2
PLUG (Ref # 92066A)	92066-1285	1
PLUG (Ref # 92066B)	92066-1302	2

1996 Vulcan 1500 PARTS LIST

Front Fork

ITEM NAME	PART NUMBER	QUANTITY
SEAL,FORK (Ref # 92093)	92093-1268	2
COLLAR,FORK SPRING (Ref # 92143)	92143-1053	2
BOLT,SOCKET,10X40 (Ref # 92150)	92150-1029	1
BOLT,SOCKET,12MM (Ref # 92150A)	92150-1030	2
BOLT,SOCKET,8MM (Ref # 92150B)	92150-1031	2