

1989 Vulcan 88 PARTS DIAGRAM

Brake Pedal

F2260-0187

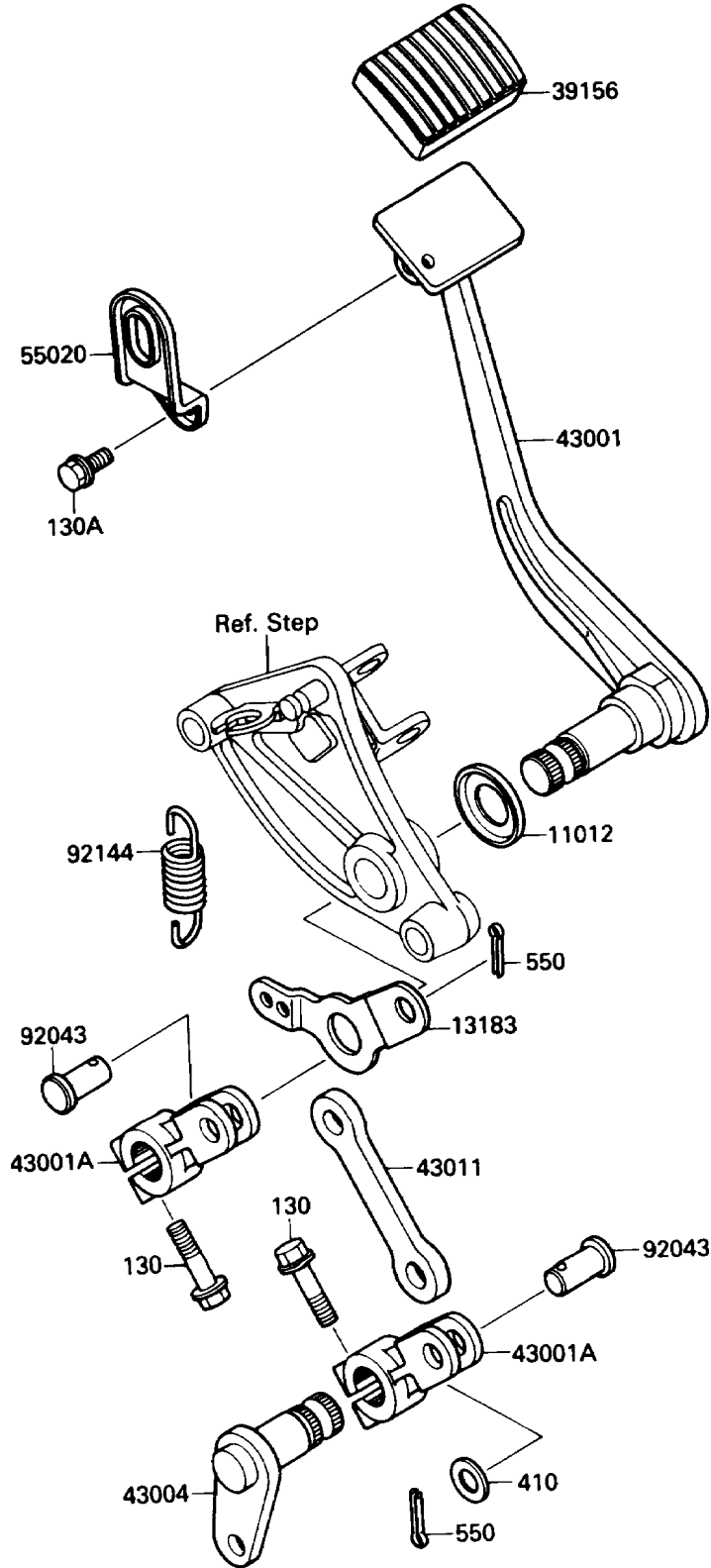

1989 Vulcan 88 PARTS LIST

Brake Pedal

| ITEM NAME | PART NUMBER | QUANTITY |
|---|-------------|----------|
| CAP,BRAKE PEDAL (Ref # 11012) | 11012-1582 | 1 |
| PLATE,BRAKE PEDAL RETURN (Ref # 13183) | 13183-1099 | 1 |
| PAD,BRAKE PEDAL (Ref # 39156) | 39156-1071 | 1 |
| LEVER-BRAKE,PEDAL (Ref # 43001) | 43001-1222 | 1 |
| LEVER-BRAKE,LINK (Ref # 43001A) | 43001-1223 | 1 |
| SHAFT-BRAKE (Ref # 43004) | 43004-1121 | 1 |
| ROD-BRAKE (Ref # 43011) | 43011-1137 | 1 |
| GUARD,BRAKE PEDAL (Ref # 55020) | 55020-1268 | 1 |
| PIN,10X20.5 (Ref # 92043) | 92043-1352 | 1 |
| SPRING,BRAKE PEDAL RETURN (Ref # 92144) | 92144-1169 | 1 |
| BOLT-FLANGED,8X25,BLACK (Ref # 130) | 130J0825 | 1 |
| BOLT-FLANGED,6X8 (Ref # 130A) | 130N0608 | 1 |
| WASHER-PLAIN-SMALL,10MM,BLACK (Ref # 410) | 410F1000 | 1 |
| PIN-COTTER,2.0X15 (Ref # 550) | 550D2015 | 1 |