

1988 Vulcan 88 PARTS DIAGRAM

Brake Pedal

F2260-0187

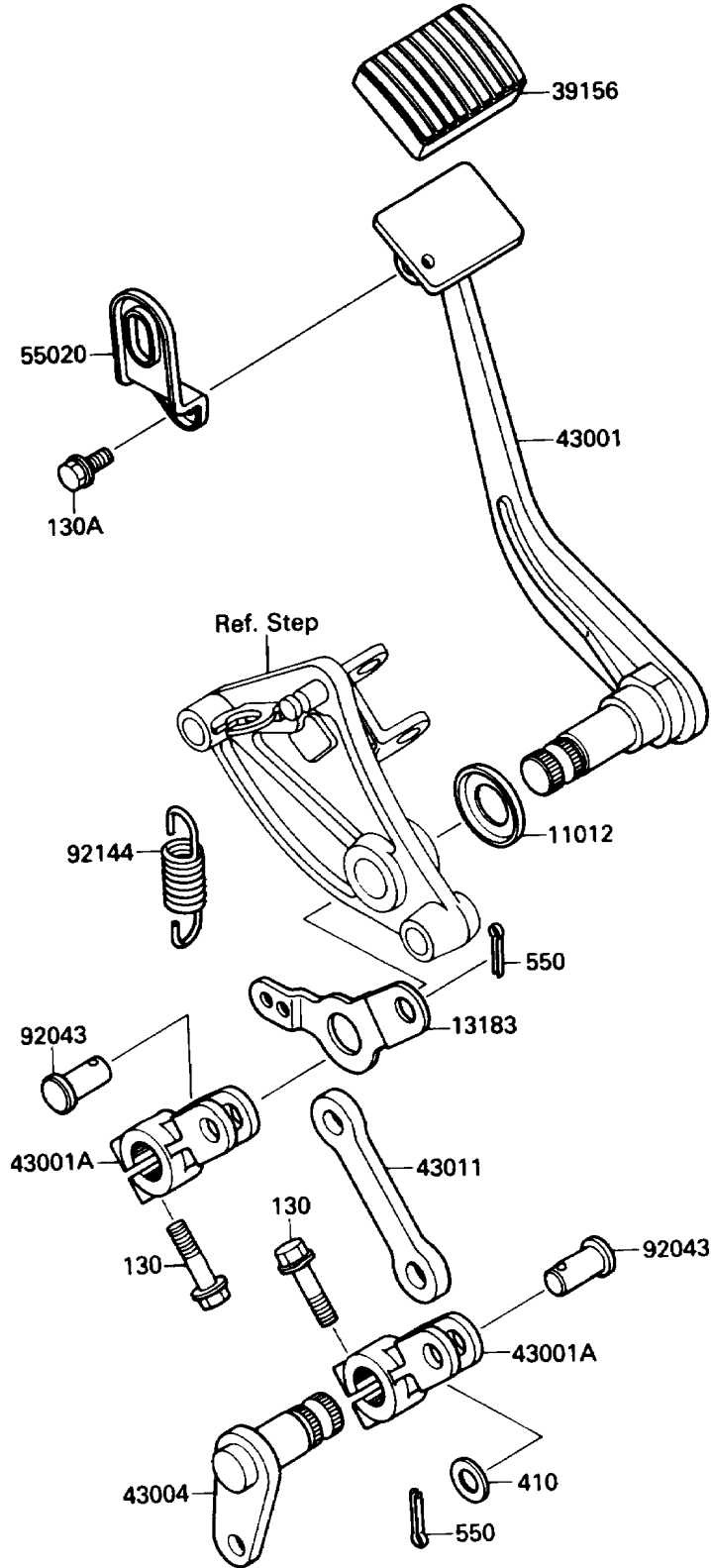

1988 Vulcan 88 PARTS LIST

Brake Pedal

ITEM NAME	PART NUMBER	QUANTITY
CAP,BRAKE PEDAL (Ref # 11012)	11012-1582	1
PLATE,BRAKE PEDAL RETURN (Ref # 13183)	13183-1099	1
PAD,BRAKE PEDAL (Ref # 39156)	39156-1071	1
LEVER-BRAKE,PEDAL (Ref # 43001)	43001-1222	1
LEVER-BRAKE,LINK (Ref # 43001A)	43001-1223	2
SHAFT-BRAKE (Ref # 43004)	43004-1121	1
ROD-BRAKE (Ref # 43011)	43011-1137	1
GUARD,BRAKE PEDAL (Ref # 55020)	55020-1268	1
PIN,10X20.5 (Ref # 92043)	92043-1352	2
SPRING,BRAKE PEDAL RETURN (Ref # 92144)	92144-1169	1
BOLT-FLANGED,8X25,BLACK (Ref # 130)	130J0825	2
BOLT-FLANGED,6X8 (Ref # 130A)	130N0608	1
WASHER-PLAIN-SMALL,10MM,BLACK (Ref # 410)	410F1000	1
PIN-COTTER,2.0X15 (Ref # 550)	550D2015	2