

1989 Vulcan 88 PARTS DIAGRAM

Crankcase

E1411-0171

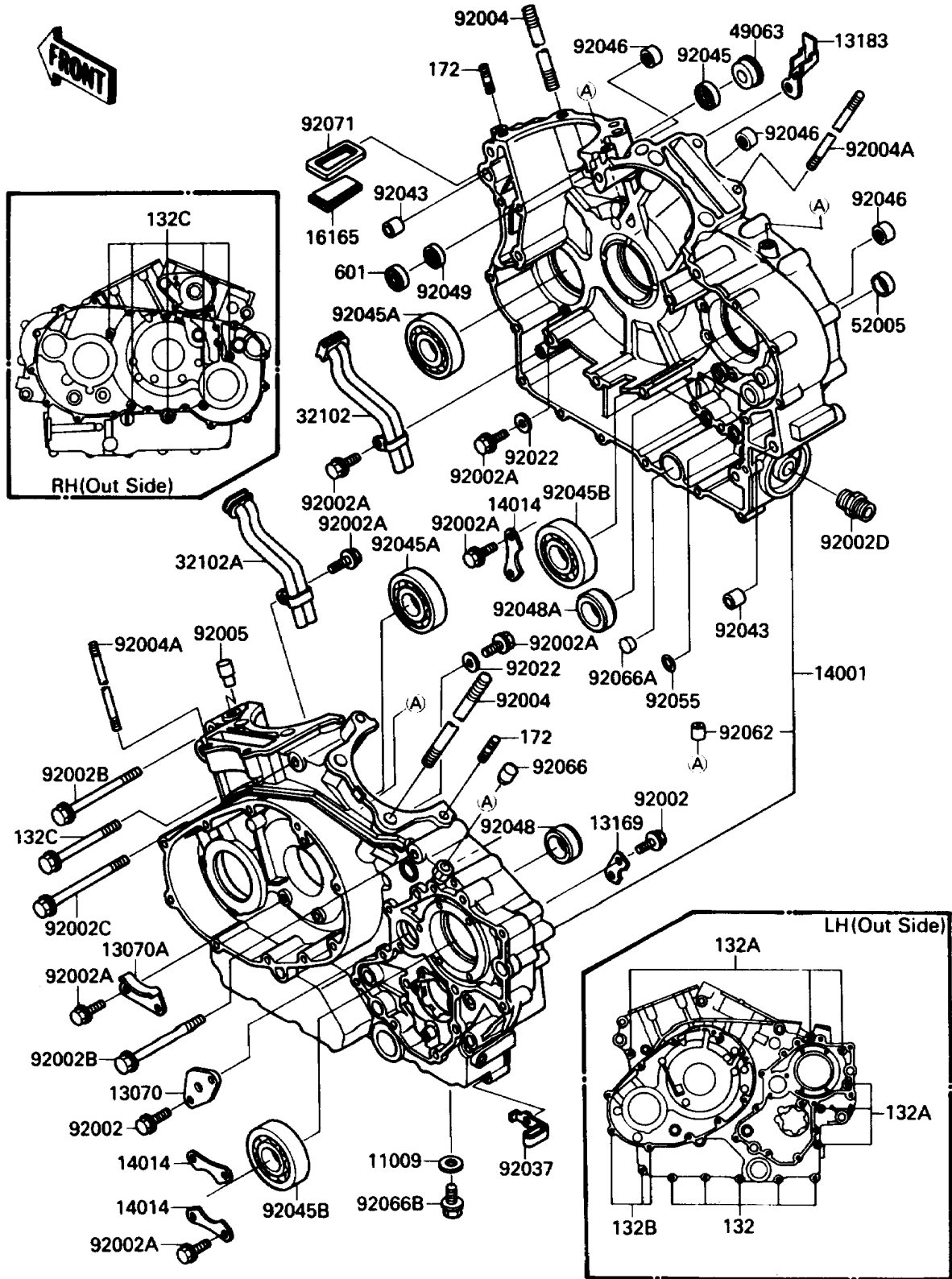

1989 Vulcan 88 PARTS LIST

Crankcase

ITEM NAME	PART NUMBER	QUANTITY
GASKET,12X22X2,DRAIN PLUG (Ref # 11009)	92065-097	1
GUIDE,PUSH ROD (Ref # 13070)	13070-1167	1
GUIDE,CAM CHAIN (Ref # 13070A)	13070-1168	1
PLATE,GEAR CHANGE DRUM (Ref # 13169)	13169-014	1
PLATE (Ref # 13183)	13183-1145	1
SET-CRANKCASE (Ref # 14001)	14001-5232	1
PLATE-POSITION (Ref # 14014)	14014-1084	1
SEPARATOR (Ref # 16165)	16165-1058	1
PIPE (Ref # 32102)	32102-1407	1
PIPE (Ref # 32102A)	32102-1708	1
SEAL-MECHANICAL (Ref # 49063)	49063-1052	1
GAUGE,OIL LEVEL (Ref # 52005)	52005-1009	1
BOLT,6X16 (Ref # 92002)	92002-1439	1
BOLT,6X12 (Ref # 92002A)	92002-1563	1
BOLT,10X105 (Ref # 92002B)	92002-1897	1
BOLT,10X115 (Ref # 92002C)	92002-1898	1
BOLT,OIL FILTER (Ref # 92002D)	92002-1899	1
STUD,12X252 (Ref # 92004)	92004-1172	1
STUD,8X231 (Ref # 92004A)	92004-1174	1
FITTING (Ref # 92005)	92005-1155	1
WASHER,6X19.5X2 (Ref # 92022)	92022-1517	1
CLAMP (Ref # 92037)	92037-1925	1
PIN,11X14X12.3 (Ref # 92043)	92043-1266	1
BEARING-BALL,6001LLU (Ref # 92045)	92045-1151	1
BEARING-BALL,63/28 (Ref # 92045A)	92045-1189	1
BEARING-BALL,6306SH2 (Ref # 92045B)	92045-1190	1
BEARING-NEEDLE,HK1212 (Ref # 92046)	92046-1163	1
RACE (Ref # 92048)	92048-1069	1
RACE (Ref # 92048A)	92048-1070	1

1989 Vulcan 88 PARTS LIST

Crankcase

ITEM NAME	PART NUMBER	QUANTITY
SEAL-OIL,AC037AE0 (Ref # 92049)	92049-1228	1
RING-O,13.2X2.4 (Ref # 92055)	92055-1373	1
NOZZLE,6X8 (Ref # 92062)	92062-1066	1
PLUG (Ref # 92066)	92066-1012	1
PLUG (Ref # 92066A)	92066-1110	1
PLUG,OIL DRAIN,12X15 (Ref # 92066B)	92066-1174	1
GROMMET,SEPARATOR (Ref # 92071)	92071-1153	1
BOLT-FLANGED-SMALL (Ref # 132)	132E0640	1
BOLT-FLANGED-SMALL (Ref # 132A)	132E0670	1
BOLT-FLANGED-SMALL (Ref # 132B)	132E0680	1
BOLT-FLANGED-SMALL (Ref # 132C)	132E0890	1
BOLT-STUD,8X25 (Ref # 172)	172G0825	1
BEARING-BALL (Ref # 601)	601A6001	1