

1989 Vulcan 88 PARTS DIAGRAM

Cylinder/Piston

E1120

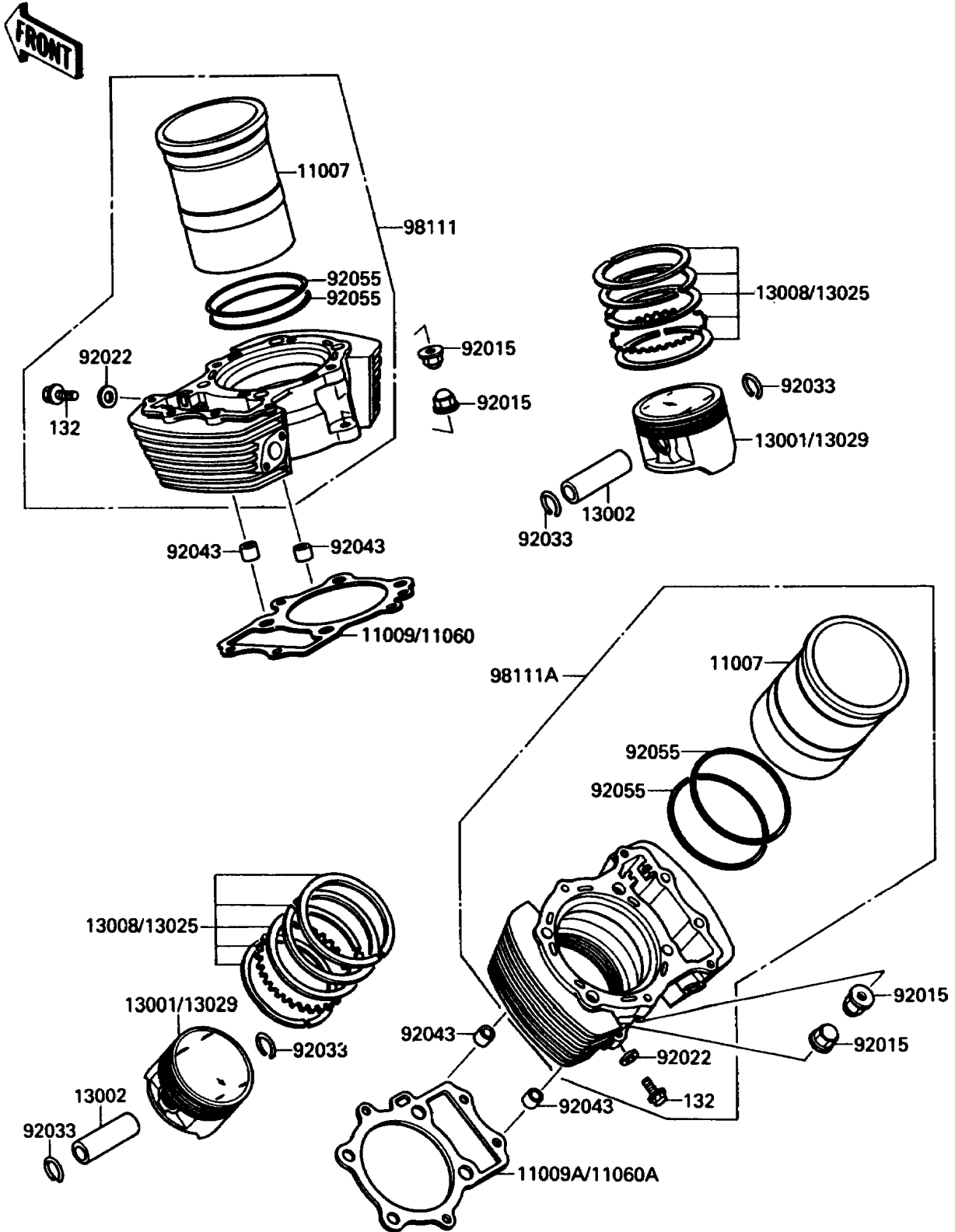

1989 Vulcan 88 PARTS LIST

Cylinder/Piston

ITEM NAME	PART NUMBER	QUANTITY
LINER-CYLINDER (Ref # 11007)	11007-1097	1
GASKET,CYLINDER BASE,FR (Ref # 11009)	11009-1642	1
GASKET,CYLINDER BASE,RR (Ref # 11009A)	11009-1643	1
PISTON-ENGINE,STD (Ref # 13001)	13001-1276	1
PIN-PISTON (Ref # 13002)	13002-1070	1
RING-SET-PISTON,STD (Ref # 13008)	13008-1086	1
RING-SET-PISTON L,O/S 0.50 (Ref # 13025)	13025-1081	1
PISTON-ENGINE L,O/S 0.50 (Ref # 13029)	13029-1173	1
NUT,CAP,8MM (Ref # 92015)	92015-1371	1
WASHER,6.1X12X1 (Ref # 92022)	92022-077	1
RING-SNAP (Ref # 92033)	92033-1226	1
PIN,DOWEL,13X16X14 (Ref # 92043)	92043-1349	1
RING-O,110.5X2.5 (Ref # 92055)	92055-1371	1
CYLINDER-COMP-ENGINE,FR (Ref # 98111)	98111-1052	1
CYLINDER-COMP-ENGINE,RR (Ref # 98111A)	98111-1053	1
BOLT-FLANGED-SMALL (Ref # 132)	132E0610	1