

2019 MULE SX™ 4x4 XC SE PARTS DIAGRAM

Other

F2750

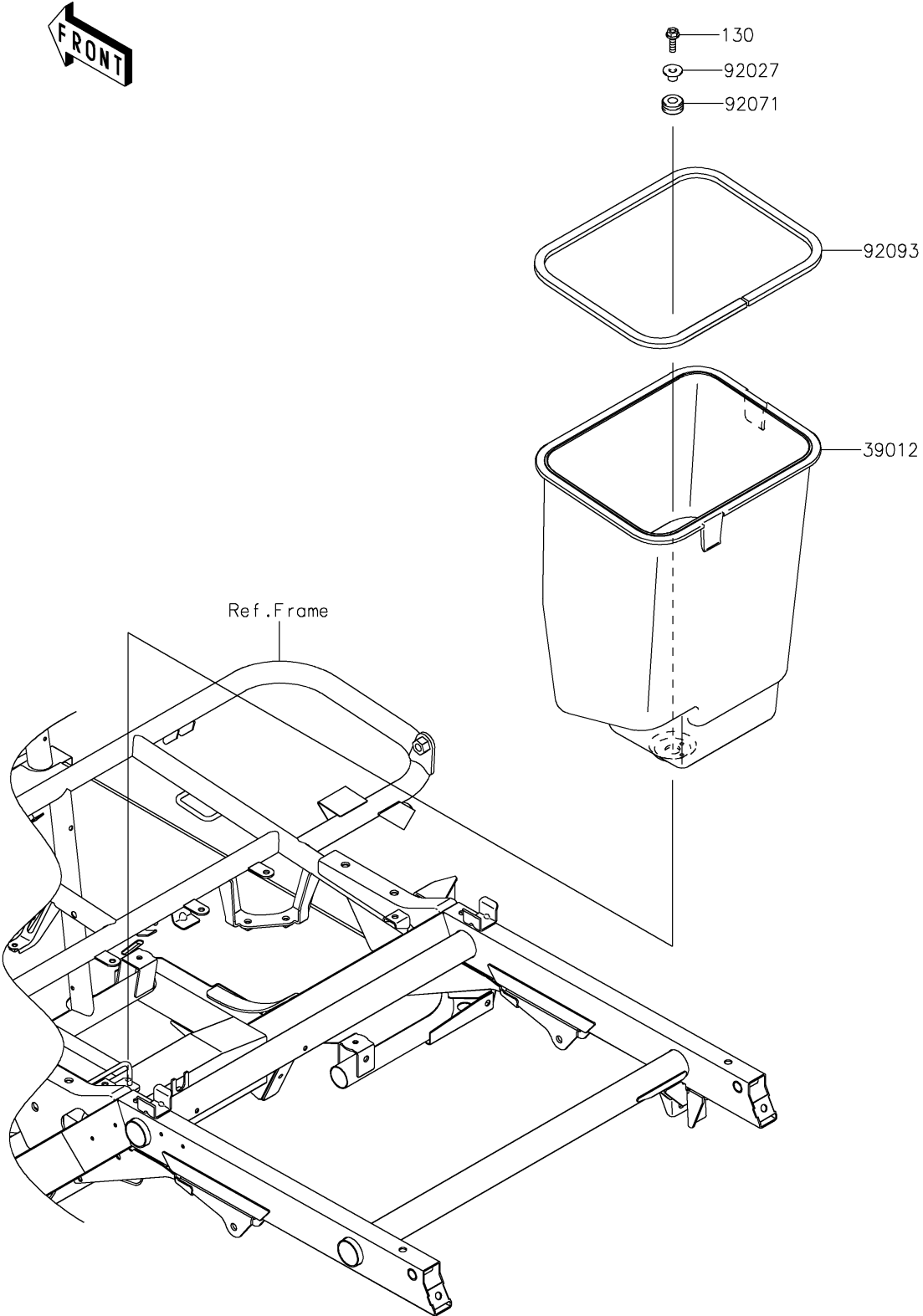

2019 MULE SX™ 4x4 XC SE PARTS LIST

Other

ITEM NAME	PART NUMBER	QUANTITY
CASE-STORAGE (Ref # 39012)	39012-0006	1
COLLAR (Ref # 92027)	92027-1767	1
GROMMET (Ref # 92071)	92071-1010	1
SEAL,6X10X795 (Ref # 92093)	92093-0700	1
BOLT-FLANGED,6X20 (Ref # 130)	130BA0620	1