

2017 MULE SX™ PARTS DIAGRAM

Labels

F2860

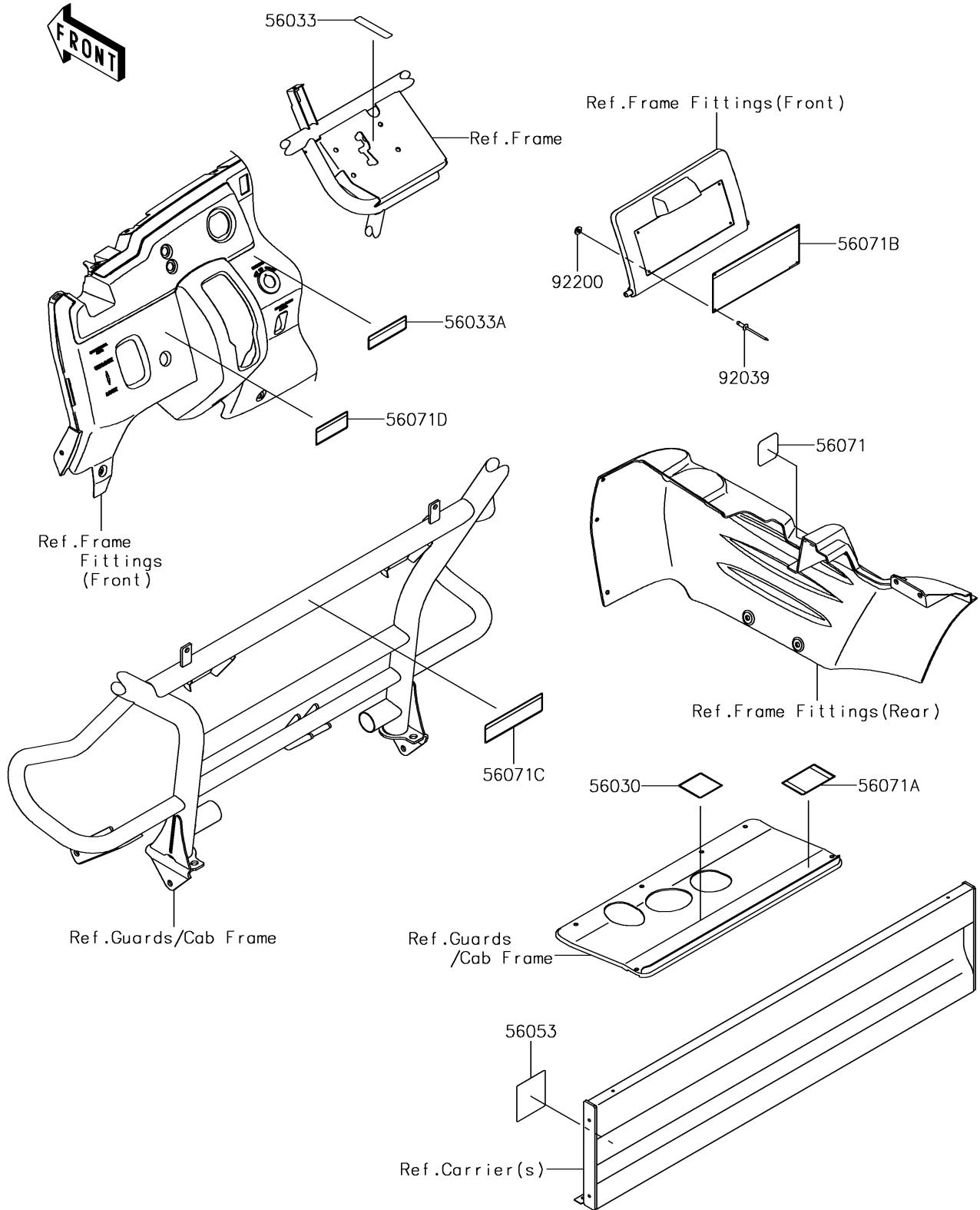

2017 MULE SX™ PARTS LIST

Labels

ITEM NAME	PART NUMBER	QUANTITY
LABEL,OIL GAUGE (Ref # 56030)	56030-0984	1
LABEL-MANUAL,SHIFT (Ref # 56033)	56033-0062	1
LABEL-MANUAL,SHIFT NOTICE (Ref # 56033A)	56033-0822	1
LABEL-SPECIFICATION,TIRE&LOAD (Ref # 56053)	56053-1170	1
LABEL-WARNING,GASOLINE (Ref # 56071)	56071-0588	1
LABEL-WARNING,HOT SURFACE (Ref # 56071A)	56071-0596	1
LABEL-WARNING,GENERAL (Ref # 56071B)	56071-0597	1
LABEL-WARNING,CARGO BED (Ref # 56071C)	56071-0599	1
LABEL-WARNING,CARGO BED (Ref # 56071D)	56071-0638	1
RIVET,3.2X8 (Ref # 92039)	92039-3763	4
WASHER,3.5X8X1 (Ref # 92200)	92200-1251	4