

# 2000 Police 1000 PARTS DIAGRAM

Turn Signals

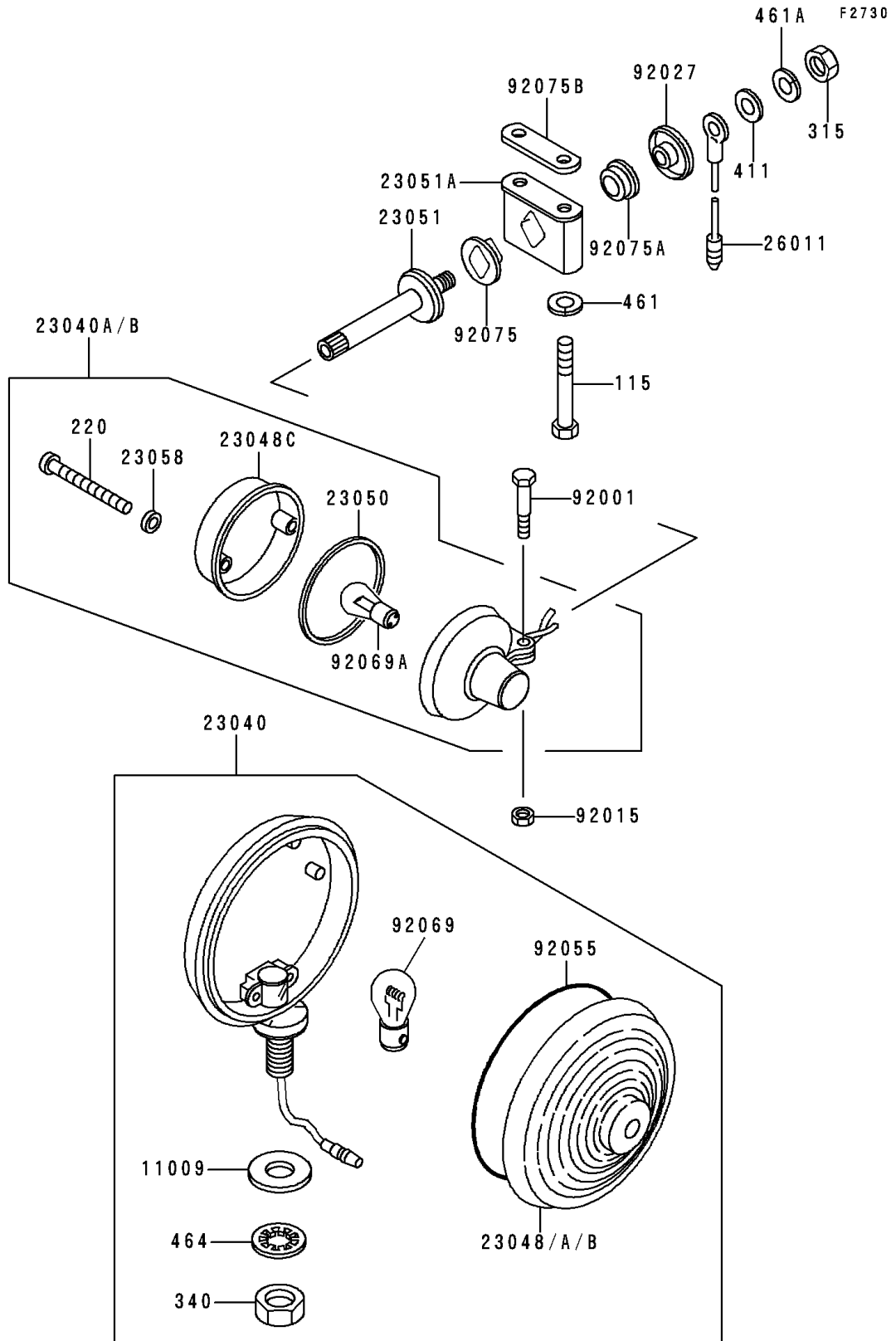

## 2000 Police 1000 PARTS LIST

### Turn Signals

ITEM NAME	PART NUMBER	QUANTITY
BOLT-SMALL-UPSET (Ref # 115)	115B0855	4
SCREW-PAN-CROS (Ref # 220)	220R0435	4
NUT-HEX-FINE,10MM (Ref # 315)	315B1000	2
NUT-UNF SC,16MM (Ref # 340)	340BA1600	2
WASHER-PLAIN,10MM (Ref # 411)	411B1000	2
WASHER-SPRING,8MM (Ref # 461)	461F0800	4
WASHER-SPRING,10MM (Ref # 461A)	461F1000	2
WASHER-TOOTHED,12MM (Ref # 464)	464H1200	2
GASKET (Ref # 11009)	11009-1291	2
LAMP-SIGNAL,RR (Ref # 23040)	23040-055	2
LAMP-SIGNAL,RH (Ref # 23040A)	23040-1005	1
LAMP-SIGNAL,LH (Ref # 23040B)	23040-1006	1
LENS-SIGNAL LAMP,REAR,AMBER (Ref # 23048)	23048-018	2
LENS-SIGNAL LAMP,REAR,RED (Ref # 23048A)	23048-019	2
LENS-SIGNAL LAMP,REAR,BLUE (Ref # 23048B)	23048-020	2
LENS-SIGNAL LAMP,"6.1445"MARK (Ref # 23048C)	23048-1024	2
GASKET,TURN SIGNAL LAMP (Ref # 23050)	23050-002	2
BRACKET-SIGNAL LAMP (Ref # 23051)	23051-1014	2
BRACKET-SIGNAL LAMP,FR (Ref # 23051A)	23051-4002	2
WASHER,PLAIN,4MM (Ref # 23058)	23058-002	4
WIRE-LEAD,L=285 (Ref # 26011)	26011-095	2
BOLT,6X30,CR PLATED (Ref # 92001)	92001-1746	2
NUT,FLANGED,6MM (Ref # 92015)	92015-1193	2
COLLAR,SIGNAL LAMP (Ref # 92027)	92027-1025	2
RING-O (Ref # 92055)	92055-103	2
BULB,12V 32CP(23W) (Ref # 92069)	92069-055	2
BULB,12V 32/3CP(23/8W) (Ref # 92069A)	92069-060	2
DAMPER,TURN SIGNAL FITTING (Ref # 92075)	92075-1014	2
DAMPER (Ref # 92075A)	92075-158	2

## 2000 Police 1000 PARTS LIST

Turn Signals

ITEM NAME	PART NUMBER	QUANTITY
DAMPER (Ref # 92075B)	92075-4022	2