

1999 Police 1000 PARTS DIAGRAM

Carrier(s)

F2520

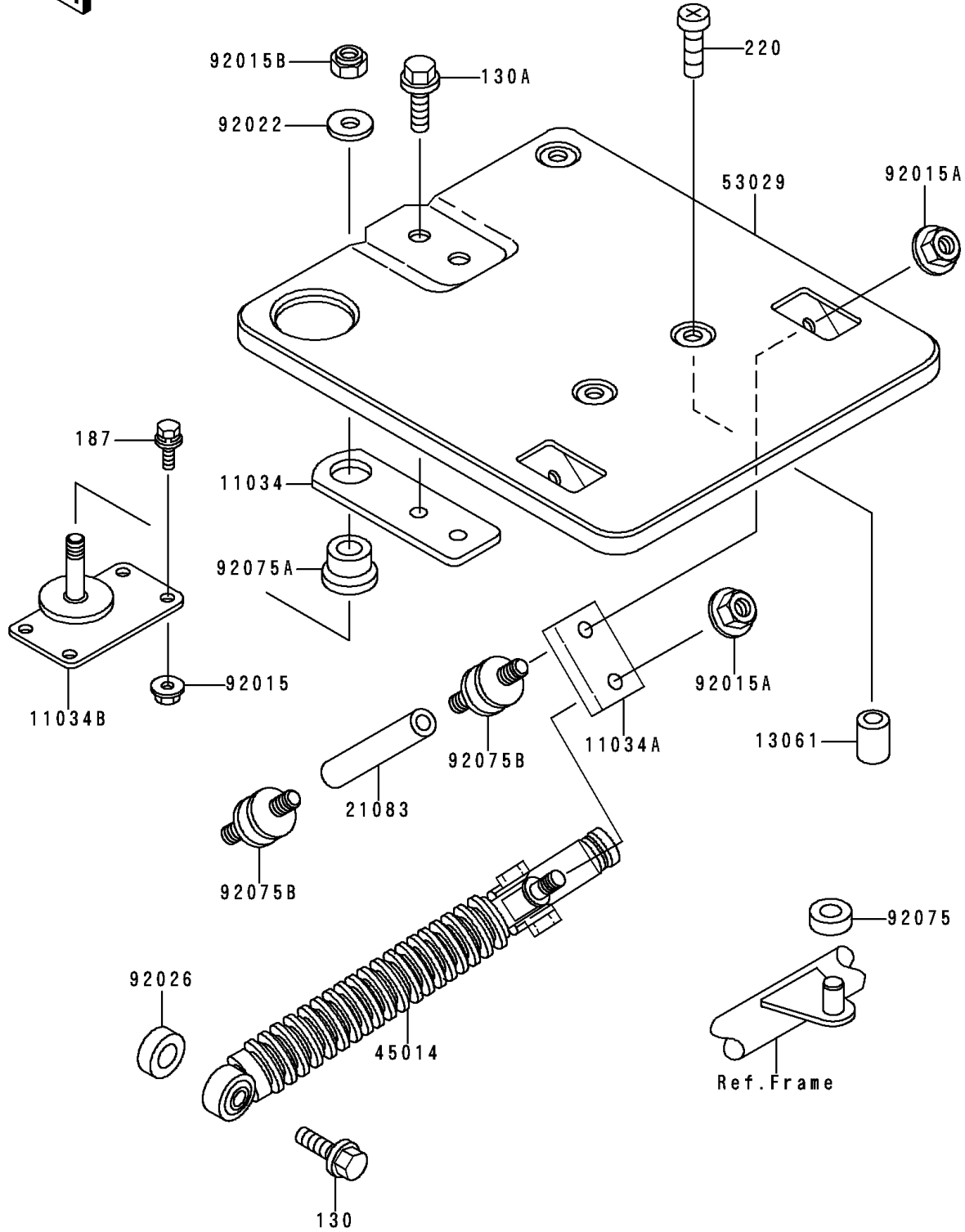

1999 Police 1000 PARTS LIST

Carrier(s)

ITEM NAME	PART NUMBER	QUANTITY
BOLT-FLANGED (Ref # 130)	130C0835	1
BOLT-FLANGED,8X16,BLACK (Ref # 130A)	130J0816	2
BOLT-UPSET-WSP,6X22 (Ref # 187)	187C0622	4
SCREW-PAN-CROS,8X14 (Ref # 220)	220B0814	2
BRACKET,CARRIER,FR (Ref # 11034)	11034-4034	1
BRACKET,CARRIER SIDE DAMPER (Ref # 11034A)	11034-4103	1
BRACKET,FR CARRIER DAMPER (Ref # 11034B)	11034-4159	1
BOSS,CARRIER SPACER (Ref # 13061)	13061-4005	2
ARM,CARRIER DAMPER (Ref # 21083)	21083-4006	2
SHOCKABSORBER,RR (Ref # 45014)	45014-4005	1
CARRIER (Ref # 53029)	53029-4002	1
NUT,FLANGED,6MM (Ref # 92015)	92015-1078	2
NUT,FLANGED,8MM,BLACK (Ref # 92015A)	92015-1183	3
NUT,LOCK,12MM,BLACK (Ref # 92015B)	92015-1190	1
WASHER (Ref # 92022)	92022-4002	1
SPACER (Ref # 92026)	92026-4003	1
DAMPER (Ref # 92075)	92075-203	1
DAMPER,CARRIER (Ref # 92075A)	92075-4006	1
DAMPER,CARRIER (Ref # 92075B)	92075-4040	4