

1994 Police 1000 PARTS DIAGRAM

Swingarm/Shock Absorber

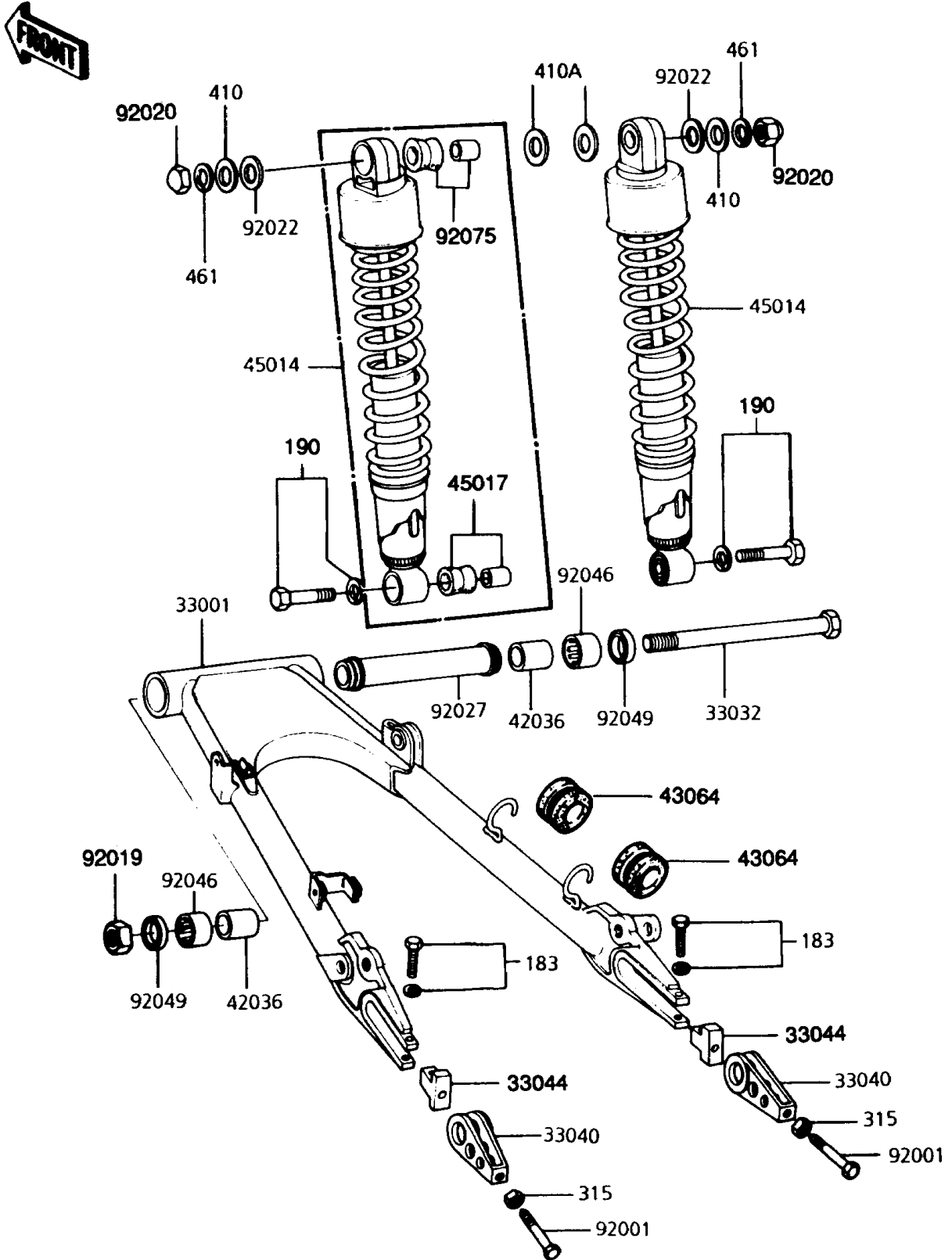

1994 Police 1000 PARTS LIST

Swingarm/Shock Absorber

ITEM NAME	PART NUMBER	QUANTITY
ARM-COMP-SWING (Ref # 33001)	33001-4006	1
SHAFT-SWING ARM (Ref # 33032)	33032-036	1
ADJUSTER-CHAIN (Ref # 33040)	33040-066	2
STOPPER,CHAIN ADJUSTER (Ref # 33044)	33044-001	2
SLEEVE,SWING ARM (Ref # 42036)	42036-1040	2
GROMMET,HOSE CLAMP (Ref # 43064)	43064-007	2
SHOCKABSORBER,RR (Ref # 45014)	45014-1174	2
DAMPER,SHOCKABSORBER,LWR (Ref # 45017)	45017-019	2
BOLT,10X50 (Ref # 92001)	92001-143	2
NUT,LOCK,16MM (Ref # 92019)	92019-005	1
NUT,CAP,12MM (Ref # 92020)	92020-014	2
WASHER,12.4X28X2.3 (Ref # 92022)	92022-1239	2
COLLAR,SWING ARM (Ref # 92027)	92027-1561	1
BEARING-NEEDLE,BHTM2530-1 (Ref # 92046)	92046-1035	2
SEAL-OIL,MH25334 (Ref # 92049)	92049-1060	2
DAMPER,SHOCKABSORBER (Ref # 92075)	92075-1141	2
BOLT-UPSET-WS-SMALL (Ref # 183)	183G0840	2
BOLT-UPSET-WS (Ref # 190)	190N1035	2
NUT-HEX-FINE,10MM (Ref # 315)	315B1000	2
WASHER-PLAIN-SMALL,12MM (Ref # 410)	410B1200	2
WASHER-PLAIN-SMALL,14MM (Ref # 410A)	410B1400	2
WASHER-SPRING,12MM (Ref # 461)	461F1200	2