

1994 Police 1000 PARTS DIAGRAM

Starter Motor

E1840-0015

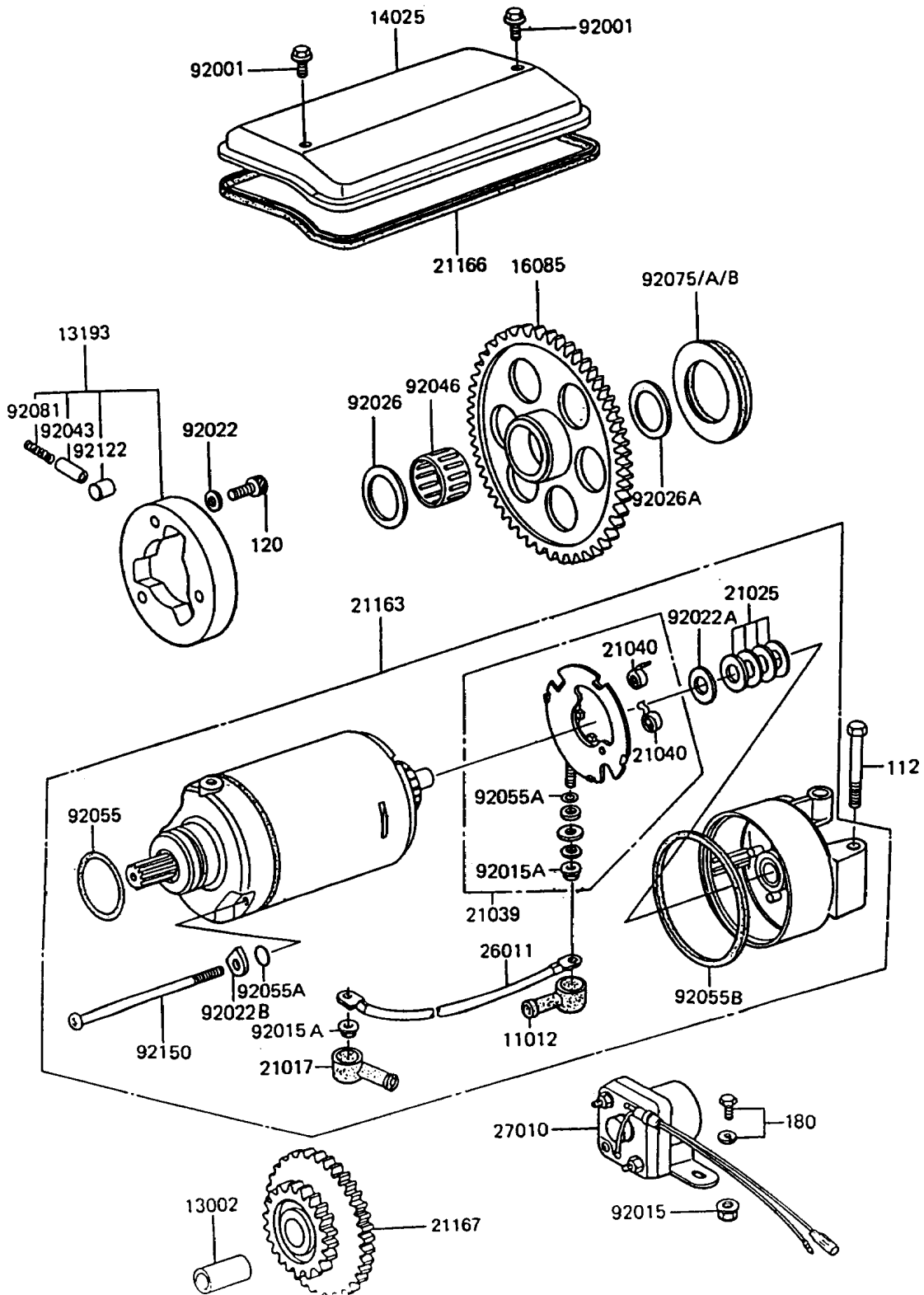

1994 Police 1000 PARTS LIST

Starter Motor

ITEM NAME	PART NUMBER	QUANTITY
CAP,TERMINAL (Ref # 11012)	11012-1354	1
PIN (Ref # 13002)	13002-007	1
CLUTCH-ASSY-ONEWAY (Ref # 13193)	13193-1006	1
COVER,STARTER (Ref # 14025)	14025-1245	1
GEAR,STARTER CLUTCH (Ref # 16085)	16085-1012	1
GROMMET,STARTER TERMINAL (Ref # 21017)	21017-017	1
WASHER,9.1X18X0.2 (Ref # 21025)	21025-011	AR
BRUSH,CARBON (Ref # 21039)	21039-1063	1
SPRING-BRUSH (Ref # 21040)	21040-1057	2
STARTER-ELECTRIC (Ref # 21163)	21163-1143	1
GASKET,STARTER COVER (Ref # 21166)	21166-001	1
GEAR-SPUR,STARTER MOTOR (Ref # 21167)	21167-002	1
WIRE-LEAD,STARTER MOTOR (Ref # 26011)	26011-1251	1
SWITCH,MAGNETIC (Ref # 27010)	27010-1047	1
BOLT,6X10 (Ref # 92001)	92001-1151	2
NUT,FLANGED,6MM (Ref # 92015)	92015-1193	2
NUT,STARTER MOTOR (Ref # 92015A)	92015-1476	2
WASHER,8.5X13.5X2 (Ref # 92022)	92022-1108	3
WASHER,9.1X18X0.8 (Ref # 92022A)	92022-1132	1
WASHER,LOCK,T=2.0 (Ref # 92022B)	92022-1458	2
SPACER,25X38X1.0 (Ref # 92026)	92026-1031	1
SPACER,25X34X2.0 (Ref # 92026A)	92026-1033	1
PIN (Ref # 92043)	92043-087	3
BEARING-NEEDLE,K253020S (Ref # 92046)	92046-1022	1
RING-O (Ref # 92055)	92055-1276	1
RING-O,4.5X2.0 (Ref # 92055A)	92055-1370	3
RING-O,STARTER MOTOR (Ref # 92055B)	92055-1381	2
DAMPER,T=6.3 (Ref # 92075)	92075-1129	AR
DAMPER,T=7.3 (Ref # 92075A)	92075-1130	AR

1994 Police 1000 PARTS LIST

Starter Motor

ITEM NAME	PART NUMBER	QUANTITY
DAMPER,T=8.3 (Ref # 92075B)	92075-1131	AR
SPRING (Ref # 92081)	92081-110	3
ROLLER,15X14.4 (Ref # 92122)	92122-001	3
BOLT (Ref # 92150)	92150-1243	2
BOLT-UPSET,6X55 (Ref # 112)	112B0655	1
BOLT-SOCKET (Ref # 120)	120P0816	3
BOLT-UPSET-WS,6X12 (Ref # 180)	180B0612	2