

1993 Police 1000 PARTS DIAGRAM

Oil Pump/Oil Filter

E1710-0025

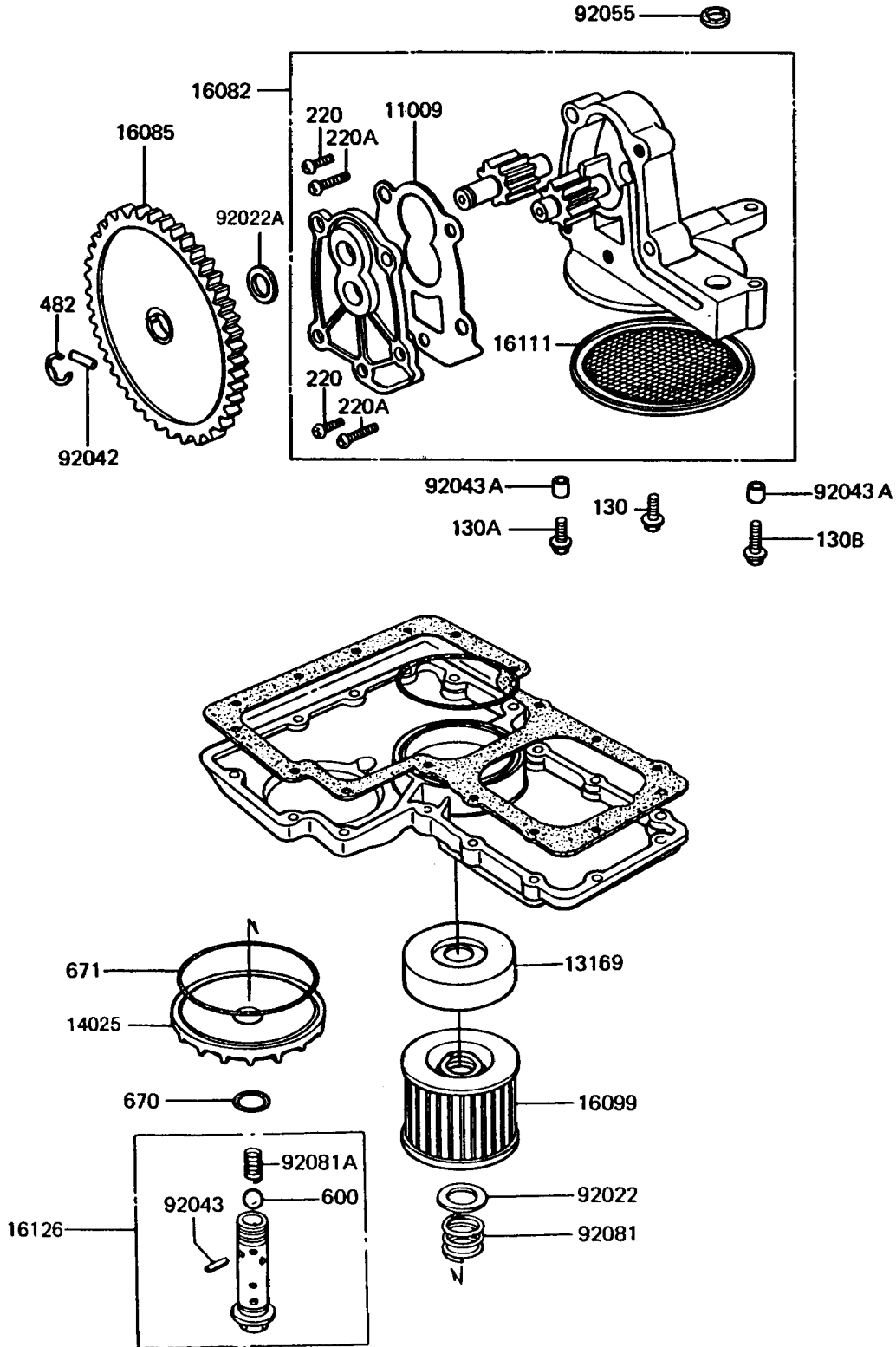

1993 Police 1000 PARTS LIST

Oil Pump/Oil Filter

ITEM NAME	PART NUMBER	QUANTITY
GASKET,OIL PUMP (Ref # 11009)	11009-1029	1
PLATE,OIL FILTER (Ref # 13169)	13169-1313	1
COVER,OIL FILTER,F.BLACK (Ref # 14025)	14025-1422	1
PUMP-ASSY-OIL (Ref # 16082)	16082-1032	1
GEAR,OIL PUMP,49T (Ref # 16085)	16085-1038	1
ELEMENT-OIL FILTER (Ref # 16099)	16099-003	1
FILTER,OIL PUMP (Ref # 16111)	16111-004	1
VALVE,OIL FILTER (Ref # 16126)	16126-1108	1
WASHER,20.5X30X1 (Ref # 92022)	92022-1012	1
WASHER,10.2X18X1.0,SK5 (Ref # 92022A)	92022-1415	1
PIN,DOWEL,4X14.8 (Ref # 92042)	92042-042	1
PIN,SPRING,2X20 (Ref # 92043)	92043-111	1
PIN,DOWEL,8X10 (Ref # 92043A)	92043-1302	2
RING-O,OD=18 (Ref # 92055)	92055-048	1
SPRING,OIL FILTER (Ref # 92081)	92081-1018	1
SPRING (Ref # 92081A)	92081-109	1
BOLT-FLANGED,6X25 (Ref # 130)	130G0625	1
BOLT-FLANGED,6X35 (Ref # 130A)	130G0635	1
BOLT-FLANGED,6X45 (Ref # 130B)	130G0645	1
SCREW-PAN-CROS,6X18 (Ref # 220)	220B0618	4
SCREW-PAN-CROS,6X28 (Ref # 220A)	220B0628	2
CIRCLIP-TYPE-E,7MM (Ref # 482)	482J7000	1
BALL-STEEL,3/8" (Ref # 600)	600A1200	1
O RING,16MM (Ref # 670)	670B2016	1
O RING,90MM (Ref # 671)	671B2590	1