

1994 Police 1000 PARTS DIAGRAM

Gear Change Mechanism

E1370-0071

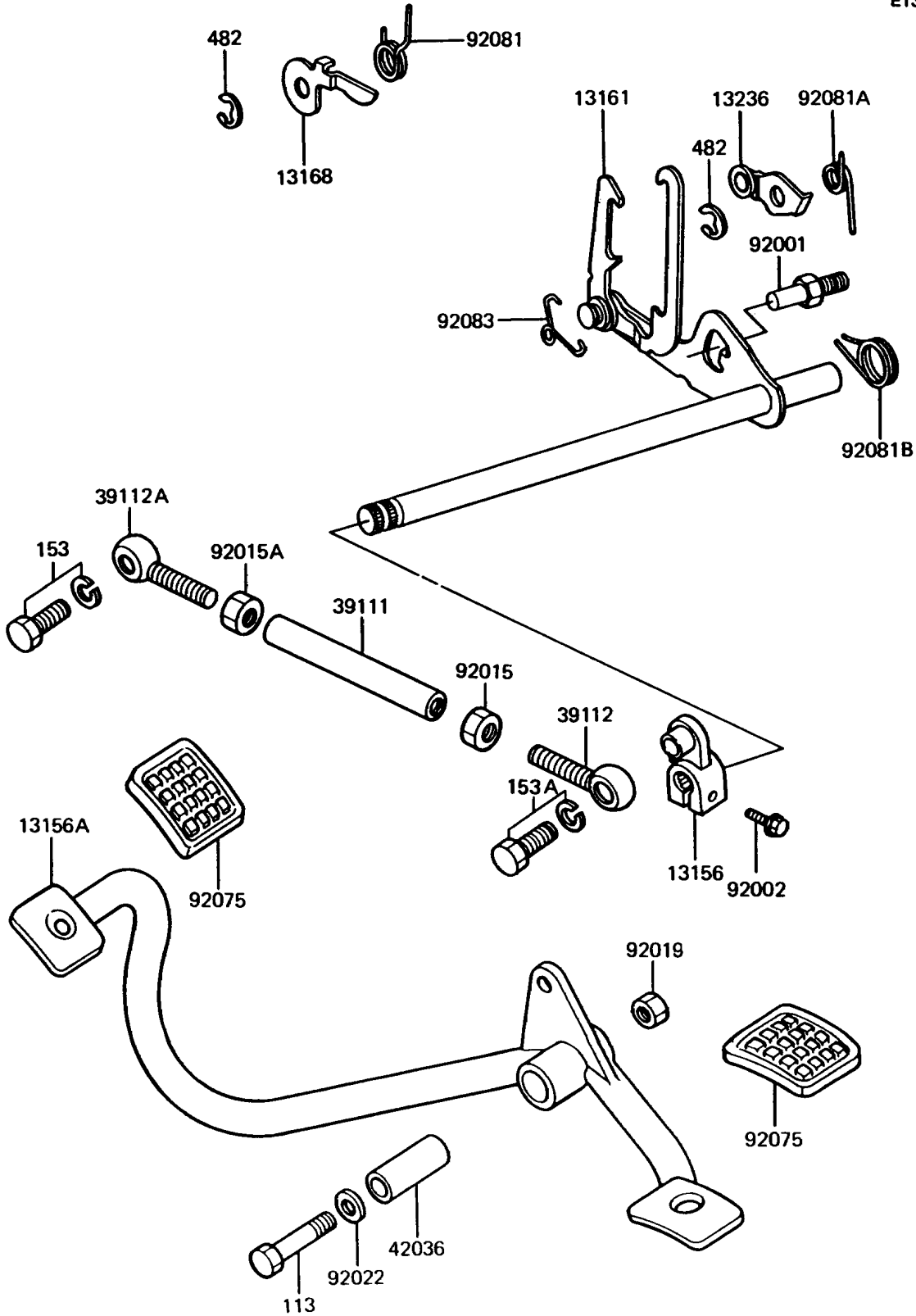

1994 Police 1000 PARTS LIST

Gear Change Mechanism

ITEM NAME	PART NUMBER	QUANTITY
LEVER-CHANGE,PEDAL (Ref # 13156)	13156-4001	1
LEVER-CHANGE,PEDAL (Ref # 13156A)	13156-4002	1
LEVER-COMP-CHANGE SHAFT (Ref # 13161)	13161-1023	1
LEVER,GEAR POSITIONING (Ref # 13168)	13168-1074	1
LEVER-COMP,NEUTRAL POSITIONING (Ref # 13236)	13236-1029	1
ROD-TIE (Ref # 39111)	39111-4001	1
RODEND-TIE,RH THREAD (Ref # 39112)	39112-1001	1
RODEND-TIE,LH THREAD (Ref # 39112A)	39112-1002	1
SLEEVE,CHANGE LEVER (Ref # 42036)	42036-4006	1
BOLT,RETURN SPRING (Ref # 92001)	92001-1455	1
BOLT,6X20 (Ref # 92002)	92002-1237	1
NUT,RH THREAD (Ref # 92015)	92015-1005	1
NUT,LH THREAD (Ref # 92015A)	92015-1006	1
NUT,LOCK,10MM (Ref # 92019)	92019-021	1
WASHER,10.5X26X2.3 (Ref # 92022)	92022-044	1
DAMPER,CHANGE PEDAL (Ref # 92075)	92075-4031	2
SPRING,POSITIONING LEVER (Ref # 92081)	92081-1284	1
SPRING,NEUTRAL POSITIONING (Ref # 92081A)	92081-1285	1
SPRING,CHANGE PEDAL RETURN (Ref # 92081B)	92081-1589	1
SPRING (Ref # 92083)	92083-018	1
BOLT-SMALL-FINE (Ref # 113)	113Y1085	1
BOLT-WS-SMALL (Ref # 153)	153Y0825	1
BOLT-WS-SMALL (Ref # 153A)	153Y0835	1
CIRCLIP-TYPE-E,6MM (Ref # 482)	482J6000	2