

1992 Big Wheel PARTS DIAGRAM

Tire(KX80-T2/T3)

F2210A

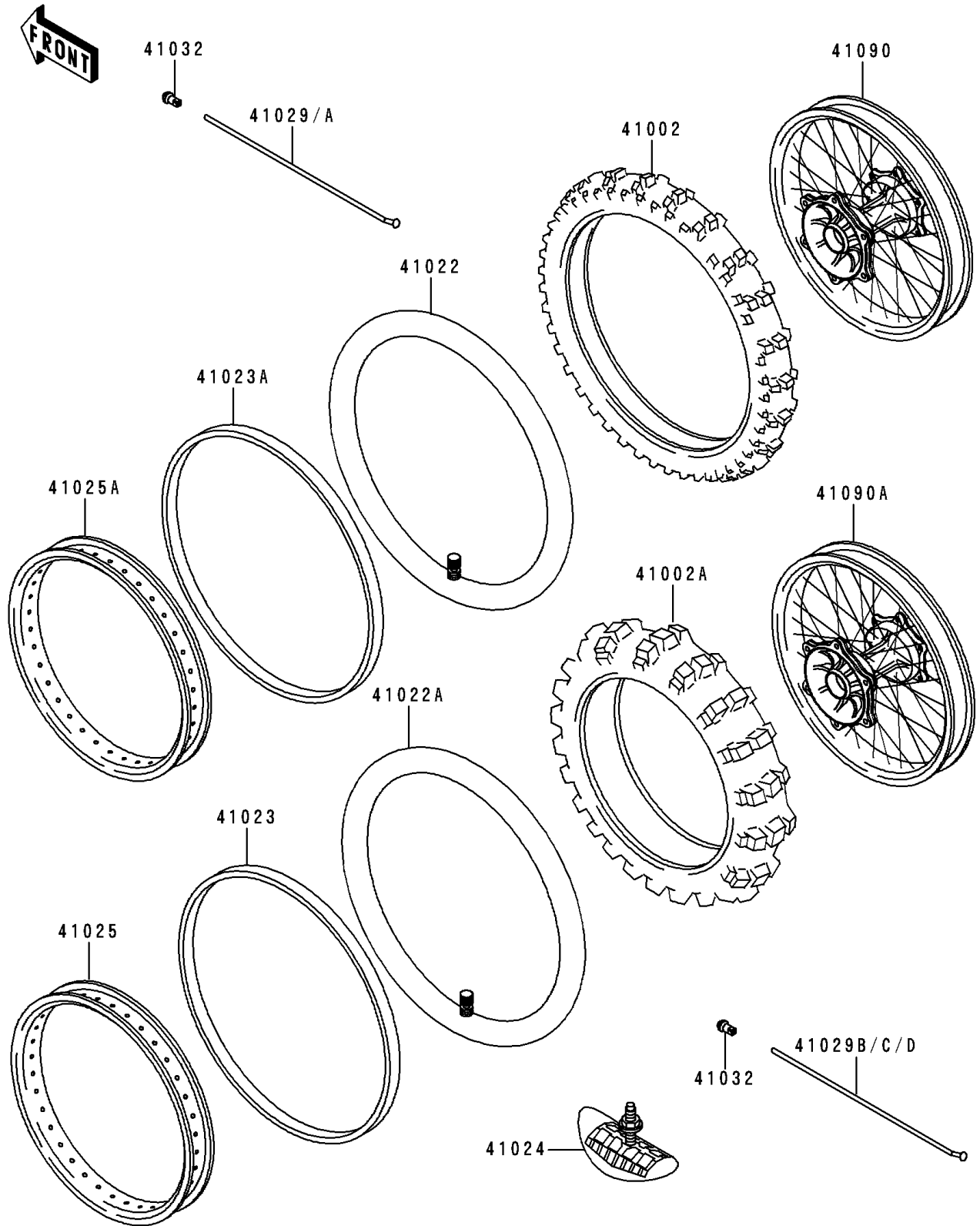

1992 Big Wheel PARTS LIST

Tire(KX80-T2/T3)

ITEM NAME	PART NUMBER	QUANTITY
TIRE,FR,70/100-19 42M,K490(D) (Ref # 41002)	41002-1626	1
TIRE,RR,90/100-16 52M,K695(D) (Ref # 41002A)	41002-1788	1
TUBE-TIRE,FR,70/100-19(D) (Ref # 41022)	41022-1121	1
TUBE-TIRE,90/100-16(D) (Ref # 41022A)	41022-1122	1
BAND-RIM,RR,90/100-16(D) (Ref # 41023)	41023-1072	1
BAND-RIM,90.100/90-19(D) (Ref # 41023A)	41023-1074	1
STOPPER-RIM,1.85-M(DUNLOP) (Ref # 41024)	41024-011	1
RIM,RR,1.85X16EN22-J (Ref # 41025)	41025-1188	1
RIM,FR,1.40X19EN22J (Ref # 41025A)	41025-1217	1
SPOKE-INNER,FR,RH,212MMX165D (Ref # 41029)	41029-1148	1
SPOKE-INNER,FR,LH,210MMX165D (Ref # 41029A)	41029-1149	1
SPOKE-INNER,RR,LH,181MMX170D (Ref # 41029B)	41029-1151	1
SPOKE-INNER,RR,RH,178MMX168D (Ref # 41029C)	41029-1181	1
SPOKE-INNER,RR,RH,175MMX168D (Ref # 41029D)	41029-1182	1
NIPPLE-SPOKE (Ref # 41032)	41032-1057	1
WHEEL-SUB ASSY,FR (Ref # 41090)	41090-1067	1
WHEEL-SUB ASSY,RR (Ref # 41090A)	41090-1078	1