

# 2008 Vulcan® 1600 Nomad™ PARTS DIAGRAM

## Clutch Master Cylinder

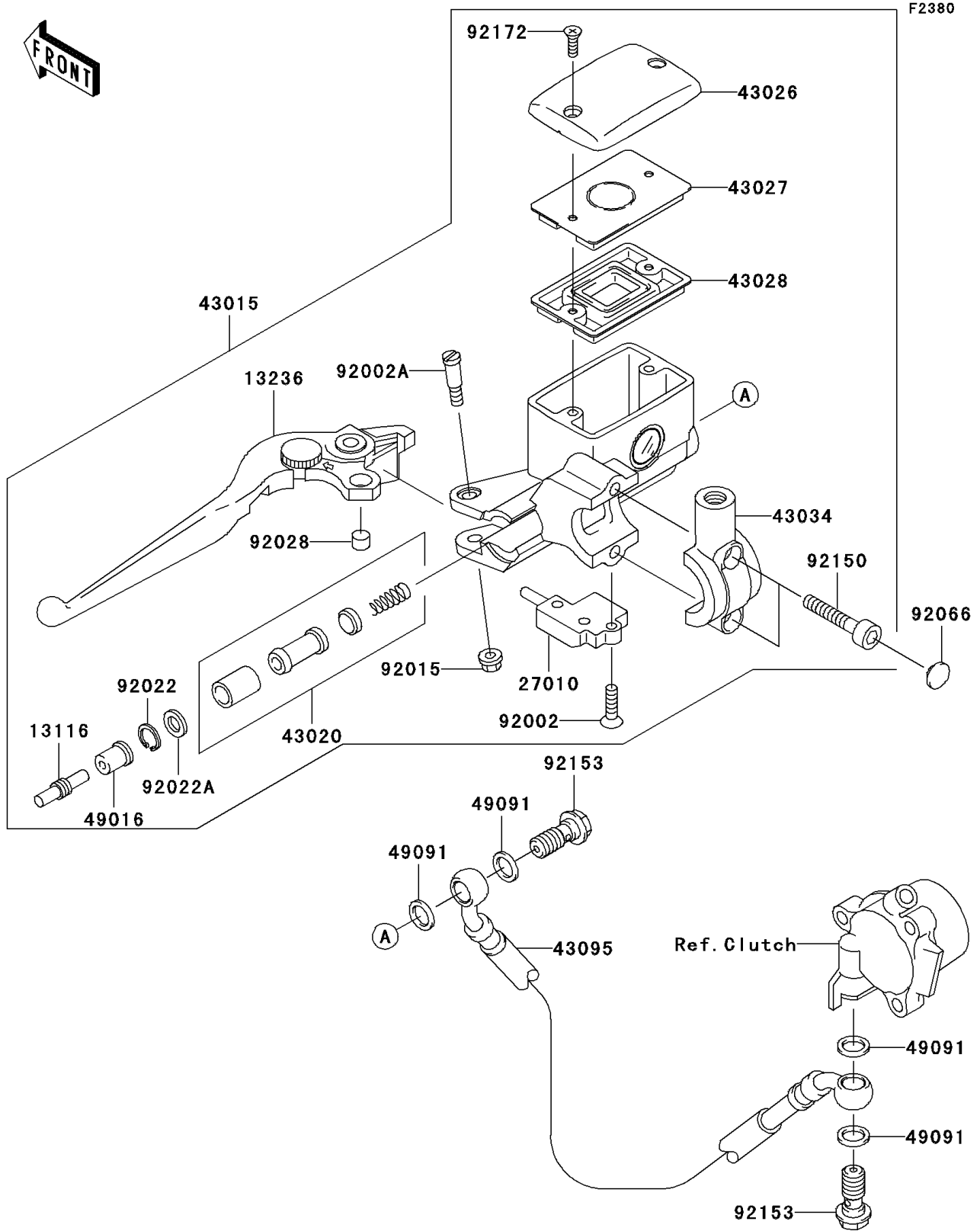

## 2008 Vulcan® 1600 Nomad™ PARTS LIST

### Clutch Master Cylinder

ITEM NAME	PART NUMBER	QUANTITY
ROD-PUSH,MASTER CYLINDER (Ref # 13116)	13116-1110	1
LEVER-COMP,CLUTCH (Ref # 13236)	13236-1316	1
SWITCH,CLUTCH (Ref # 27010)	27010-1406	1
CYLINDER-ASSY-MASTER,CLUTCH (Ref # 43015)	43015-0035	1
PISTON-COMP-BRAKE,CLUTCH (Ref # 43020)	43020-1055	1
CAP-BRAKE (Ref # 43026)	43026-0003	1
PLATE-DIAPHRAGM (Ref # 43027)	43027-1059	1
DIAPHRAGM,MASTER CYLINDER (Ref # 43028)	43028-1058	1
HOLDER-BRAKE (Ref # 43034)	43034-1172	1
HOSE-BRAKE,CLUTCH (Ref # 43095)	43095-0033	1
COVER-SEAL,MASTER CYLINDER (Ref # 49016)	49016-1044	1
WASHER-SEAL,10.1X14.5X1.5 (Ref # 49091)	49091-0001	4
SCREW,4X16 (Ref # 92002)	92002-1325	1
BOLT,LEVER SET (Ref # 92002A)	92002-1561	1
NUT,FLANGED,6MM (Ref # 92015)	92015-1528	1
CIRCLIP (Ref # 92022)	92022-1605	1
WASHER,PISTON (Ref # 92022A)	92022-1606	1
BUSHING,MASTER CYLINDER (Ref # 92028)	92028-1310	1
PLUG (Ref # 92066)	92066-1301	2
BOLT,SOCKET,6MM (Ref # 92150)	92150-1025	2
BOLT,OIL,L=23 (Ref # 92153)	92153-0627	2
SCREW (Ref # 92172)	92172-0083	2