

2000 KX60 PARTS DIAGRAM

Shock Absorber(s)

F2280

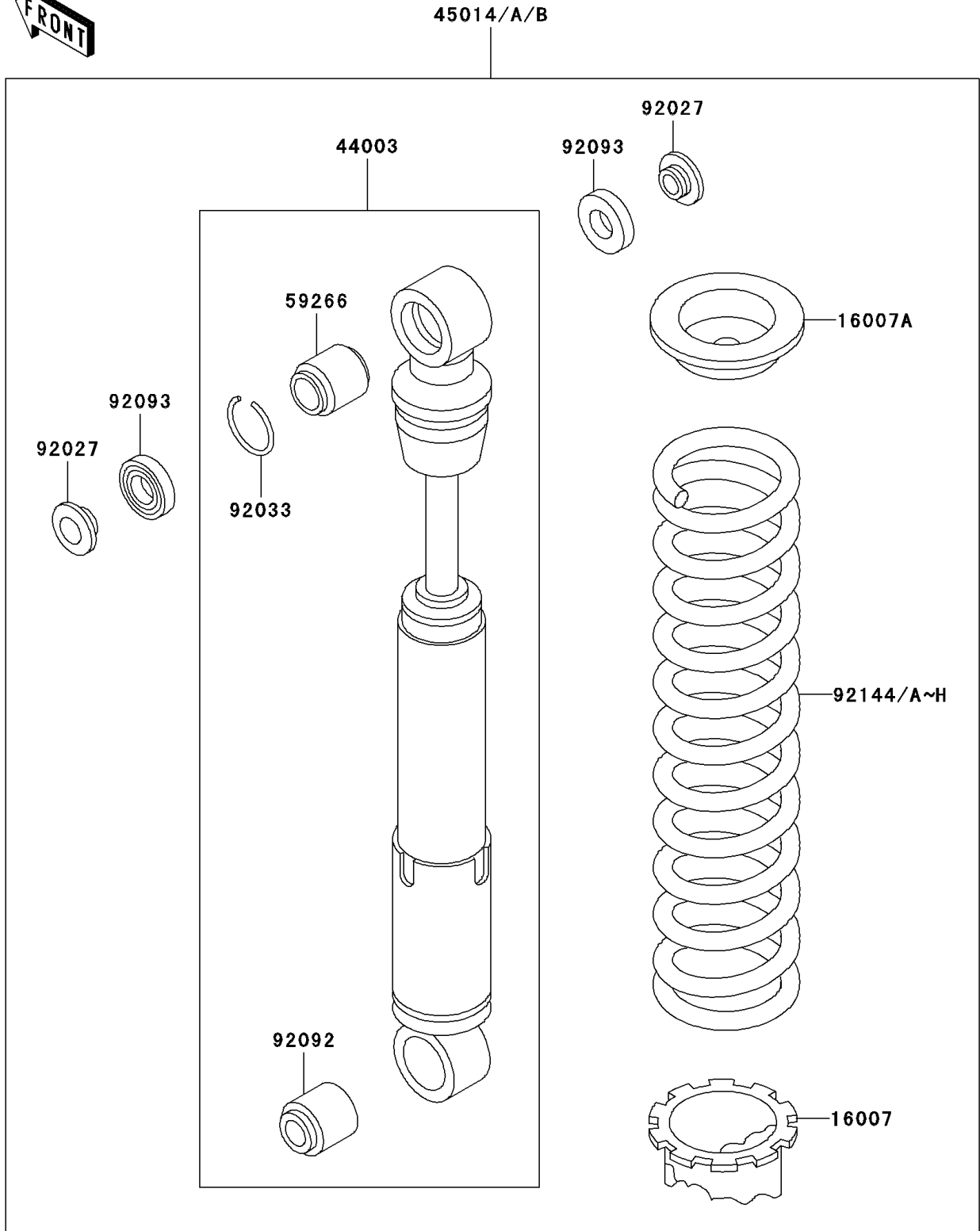

2000 KX60 PARTS LIST

Shock Absorber(s)

ITEM NAME	PART NUMBER	QUANTITY
SEAT-SPRING,REAR SHOCK,LWR (Ref # 16007)	16007-1055	1
SEAT-SPRING,REAR SHOCK,UPP (Ref # 16007A)	16007-1121	1
DAMPER-ASSY,SHOCKABSORBER (Ref # 44003)	44003-1944	1
SHOCKABSORBER,I.SILVER (Ref # 45014B)	45014-1464-8V	1
JOINT-BALL (Ref # 59266)	59266-1053	1
COLLAR (Ref # 92027)	92027-1862	2
RING-SNAP (Ref # 92033)	92033-1090	1
BUSHING-RUBBER,SHOCKABSORBER (Ref # 92092)	92092-1016	1
SEAL (Ref # 92093)	92093-1183	2
SPRING,SHOCKABSORBER,K=3.0,SIL (Ref # 92144B)	92144-1942-8V	1
SPRING,SHOCKABSORBER,K=3.3,SIL (Ref # 92144E)	92144-1943-8V	1
SPRING,SHOCKABSORBER,K=3.7,SIL (Ref # 92144H)	92144-1944-8V	1