

# 1997 KX60 PARTS DIAGRAM

Front Hub

F2230

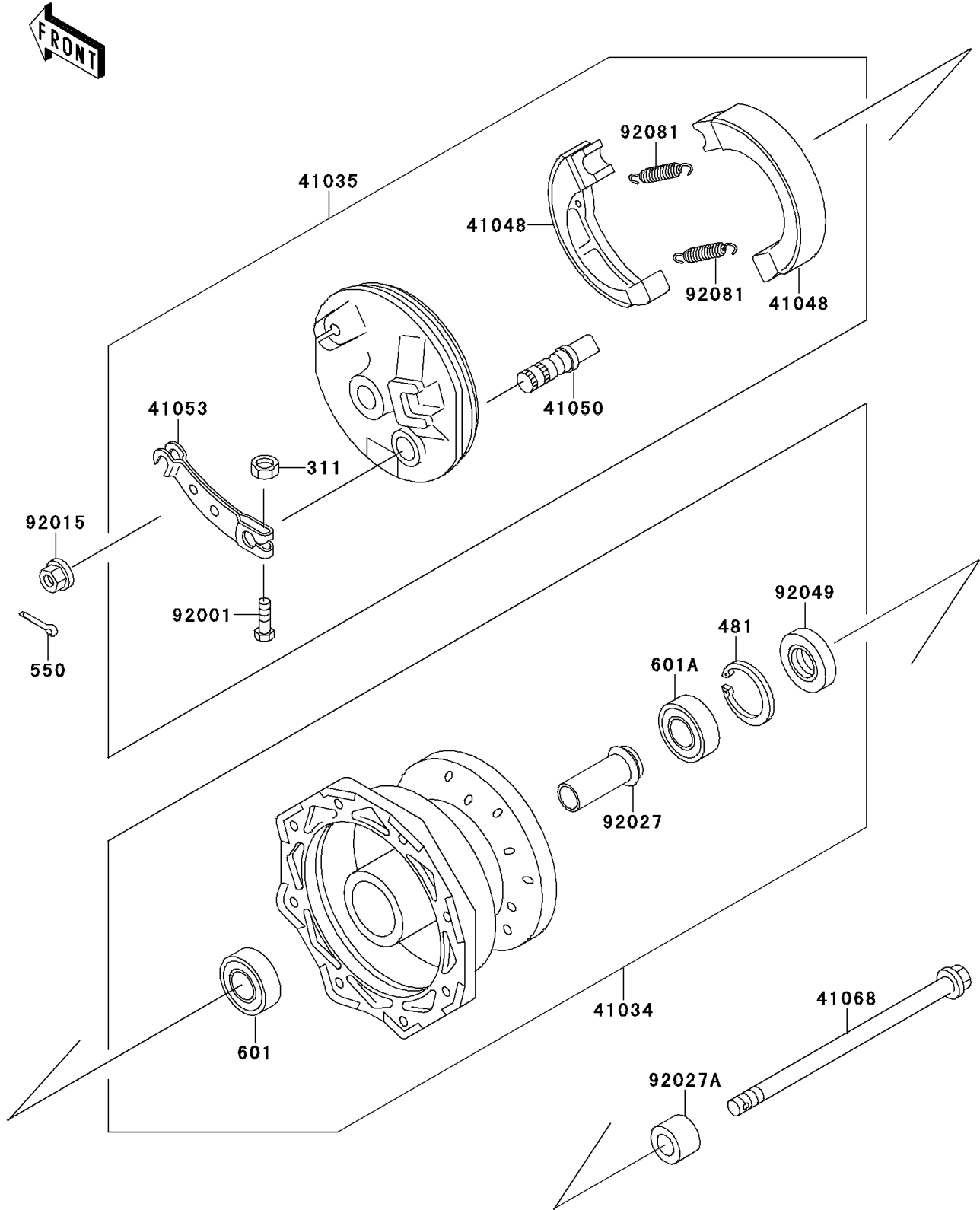

# 1997 KX60 PARTS LIST

## Front Hub

| ITEM NAME                               | PART NUMBER | QUANTITY |
|---|-------------|----------|
| NUT-HEX (Ref # 311)                     | 311G0500    | 1        |
| CIRCLIP-TYPE-C,35MM (Ref # 481)         | 481J3500    | 1        |
| PIN-COTTER,2.5X20 (Ref # 550)           | 550D2520    | 1        |
| BEARING-BALL,#6200UUC3 (Ref # 601)      | 601B6200UU  | 1        |
| BEARING-BALL,#6300UUC3 (Ref # 601A)     | 601B6300UU  | 1        |
| DRUM-ASSY,FRONT BRAKE (Ref # 41034)     | 41034-1168  | 1        |
| PANEL-ASSY-BRAKE,FR (Ref # 41035)       | 41035-1285  | 1        |
| SHOE-BRAKE (Ref # 41048)                | 41048-1083  | 2        |
| CAM-BRAKE (Ref # 41050)                 | 41050-1031  | 1        |
| LEVER-BRAKE CAM,FR (Ref # 41053)        | 41053-1027  | 1        |
| AXLE,FR (Ref # 41068)                   | 41068-1305  | 1        |
| BOLT,5X25 (Ref # 92001)                 | 92001-1695  | 1        |
| NUT,FLANGED,10MM (Ref # 92015)          | 92015-1335  | 1        |
| COLLAR,FRONT DRUM,L=54 (Ref # 92027)    | 92027-1470  | 1        |
| COLLAR,FRONT AXLE,L=14.5 (Ref # 92027A) | 92027-1472  | 1        |
| SEAL-OIL,DD20357 (Ref # 92049)          | 92049-1095  | 1        |
| SPRING,BRAKE SHOE (Ref # 92081)         | 92081-1564  | 2        |