

2003 KX500 PARTS DIAGRAM

Swingarm

F2141

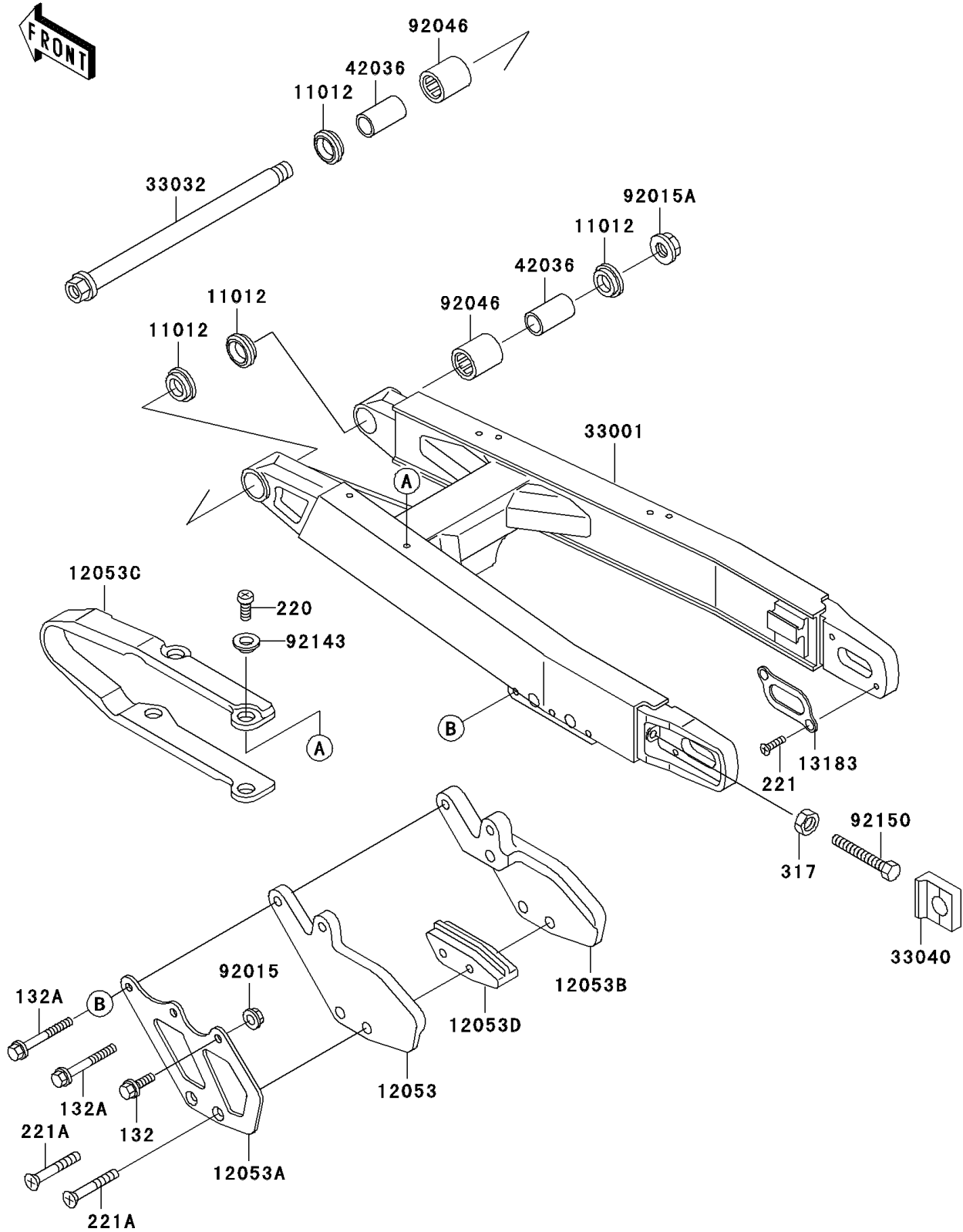

2003 KX500 PARTS LIST

Swingarm

ITEM NAME	PART NUMBER	QUANTITY
BOLT-FLANGED-SMALL (Ref # 132)	132G0616	1
BOLT-FLANGED-SMALL (Ref # 132A)	132G0635	1
SCREW-PAN-CROS,6X8 (Ref # 220)	220B0608	1
SCREW-CSK-CROS (Ref # 221)	221B0510	1
SCREW-CSK-CROS,6X45 (Ref # 221A)	221B0645	1
NUT-HEX-SMALL,8MM (Ref # 317)	317G0800	1
CAP,SWING ARM (Ref # 11012)	11012-1259	1
GUIDE-CHAIN,RR,INSIDE (Ref # 12053)	12053-1234	1
GUIDE-CHAIN,RR,OUTSIDE (Ref # 12053A)	12053-1235	1
GUIDE-CHAIN,RR,OUTSIDE (Ref # 12053B)	12053-1236	1
GUIDE-CHAIN,FR (Ref # 12053C)	12053-1240	1
GUIDE-CHAIN,DRIVE,RR,INSIDE (Ref # 12053D)	12053-1270	1
PLATE (Ref # 13183)	13183-1546	1
ARM-COMP-SWING,SILVER (Ref # 33001)	33001-1496-CE	1
SHAFT-SWING ARM (Ref # 33032)	33032-1137	1
ADJUSTER-CHAIN (Ref # 33040)	33040-1106	1
SLEEVE,SWING ARM (Ref # 42036)	42036-1064	1
NUT,FLANGED,6MM (Ref # 92015)	92015-1078	1
NUT,14MM (Ref # 92015A)	92015-1407	1
BEARING-NEEDLE,TA2030Z (Ref # 92046)	92046-1128	1
COLLAR (Ref # 92143)	92143-1156	1
BOLT,8X55 (Ref # 92150)	92150-1385	1