

2003 KX500 PARTS DIAGRAM

Frame Fittings

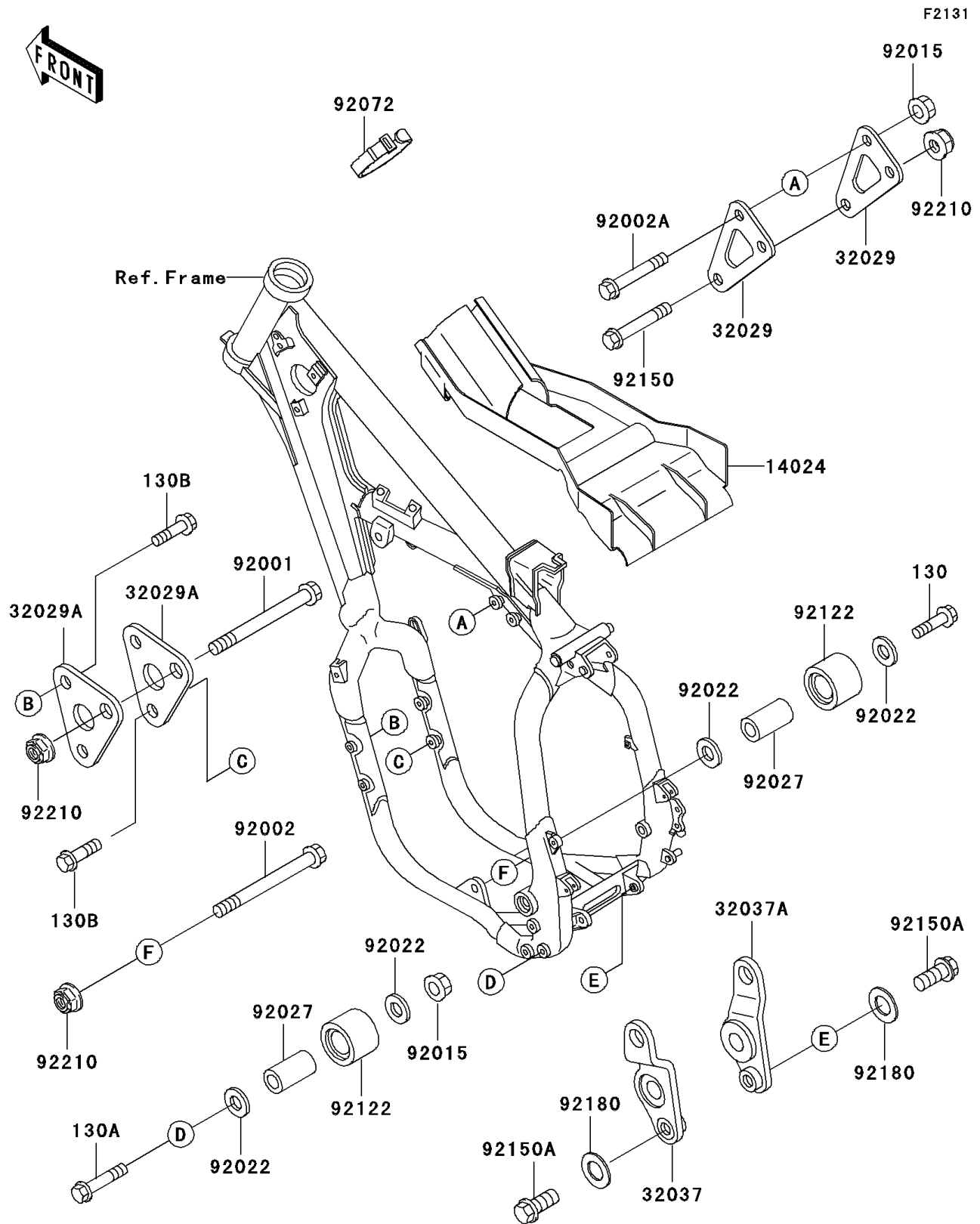

2003 KX500 PARTS LIST

Frame Fittings

ITEM NAME	PART NUMBER	QUANTITY
BOLT-FLANGED,8X40 (Ref # 130)	130G0840	1
BOLT-FLANGED,8X70 (Ref # 130A)	130G0870	1
BOLT-FLANGED (Ref # 130B)	130P0825	1
COVER,AIR FILTER (Ref # 14024)	14024-1561	1
BRACKET-ENGINE (Ref # 32029)	32029-1639	1
BRACKET-ENGINE (Ref # 32029A)	32029-1652	1
BRACKET-SHOCKABSORBER,LH (Ref # 32037)	32037-1532	1
BRACKET-SHOCKABSORBER,RH (Ref # 32037A)	32037-1533	1
BOLT,FLANGED,10X92 (Ref # 92001)	92001-1701	1
BOLT,FLANGED,10X105 (Ref # 92002)	92002-1491	1
BOLT,FLANGED,8X47 (Ref # 92002A)	92002-1850	1
NUT,8MM (Ref # 92015)	92015-1143	1
WASHER,8.5X22X1.5 (Ref # 92022)	92022-1629	1
COLLAR,CHAIN ROLLER (Ref # 92027)	92027-1670	1
BAND,L=218 (Ref # 92072)	92072-032	1
ROLLER,CHAIN GUIDE (Ref # 92122)	92122-1153	1
BOLT,FLANGED,10X50 (Ref # 92150)	92150-1125	1
BOLT,FLANGED,12X27 (Ref # 92150A)	92150-1359	1
SHIM,12.5X24X0.5 (Ref # 92180)	92180-1060	1
NUT,LOCK,FLANGED,10MM (Ref # 92210)	92210-1080	1