

2001 KX500 PARTS DIAGRAM

Wheels/Tires

F2210

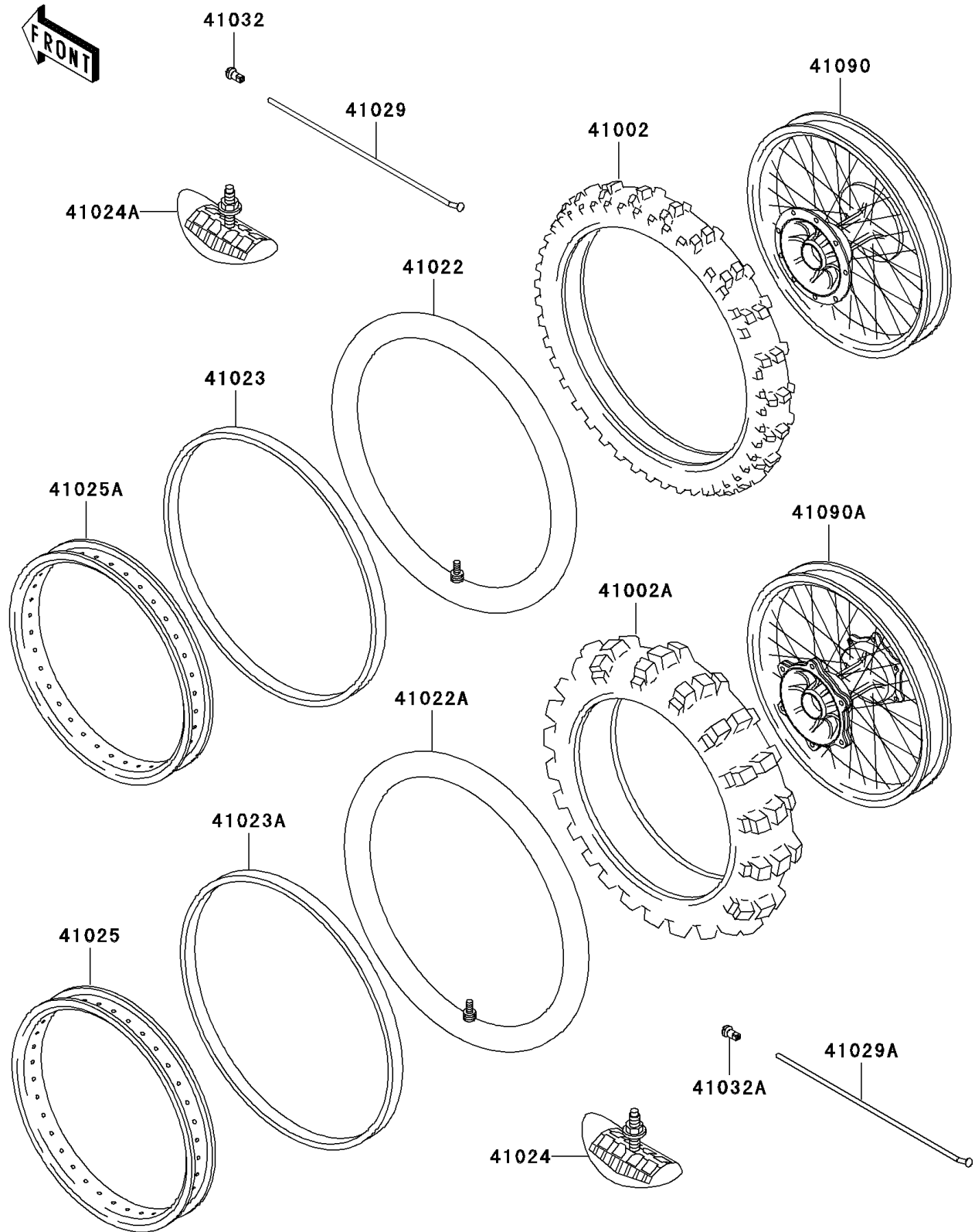

2001 KX500 PARTS LIST

Wheels/Tires

ITEM NAME	PART NUMBER	QUANTITY
TIRE,FR,80/100-21 51M,K490J(D) (Ref # 41002)	41002-1803	1
TIRE,RR,120/90-19 66M,K695(D) (Ref # 41002A)	41002-1806	1
TUBE-TIRE,80/100-21(D) (Ref # 41022)	41022-1118	1
TUBE-TIRE,110/90-19(D) (Ref # 41022A)	41022-1150	1
BAND-RIM,80/100-21(D) (Ref # 41023)	41023-1069	1
BAND-RIM,110/90-19(D) (Ref # 41023A)	41023-1084	1
STOPPER-RIM,2.15-M(DUNLOP) (Ref # 41024)	41024-009	1
STOPPER-RIM,1.60-M(DUNLOP) (Ref # 41024A)	41024-010	1
RIM,RR,2.15X19 (Ref # 41025)	41025-1239	1
RIM,FR,1.60X21 (Ref # 41025A)	41025-1241	1
SPOKE-INNER,FR,230MMX165D (Ref # 41029)	41029-1197	1
SPOKE-INNER,RR,202MMX160D (Ref # 41029A)	41029-1204	1
NIPPLE-SPOKE (Ref # 41032)	41032-1061	1
NIPPLE-SPOKE (Ref # 41032A)	41032-1064	1
WHEEL-SUB ASSY,FR (Ref # 41090)	41090-1099	1
WHEEL-SUB ASSY,RR (Ref # 41090A)	41090-1107	1