

2001 KX500 PARTS DIAGRAM

Gear Change Mechanism

E1370

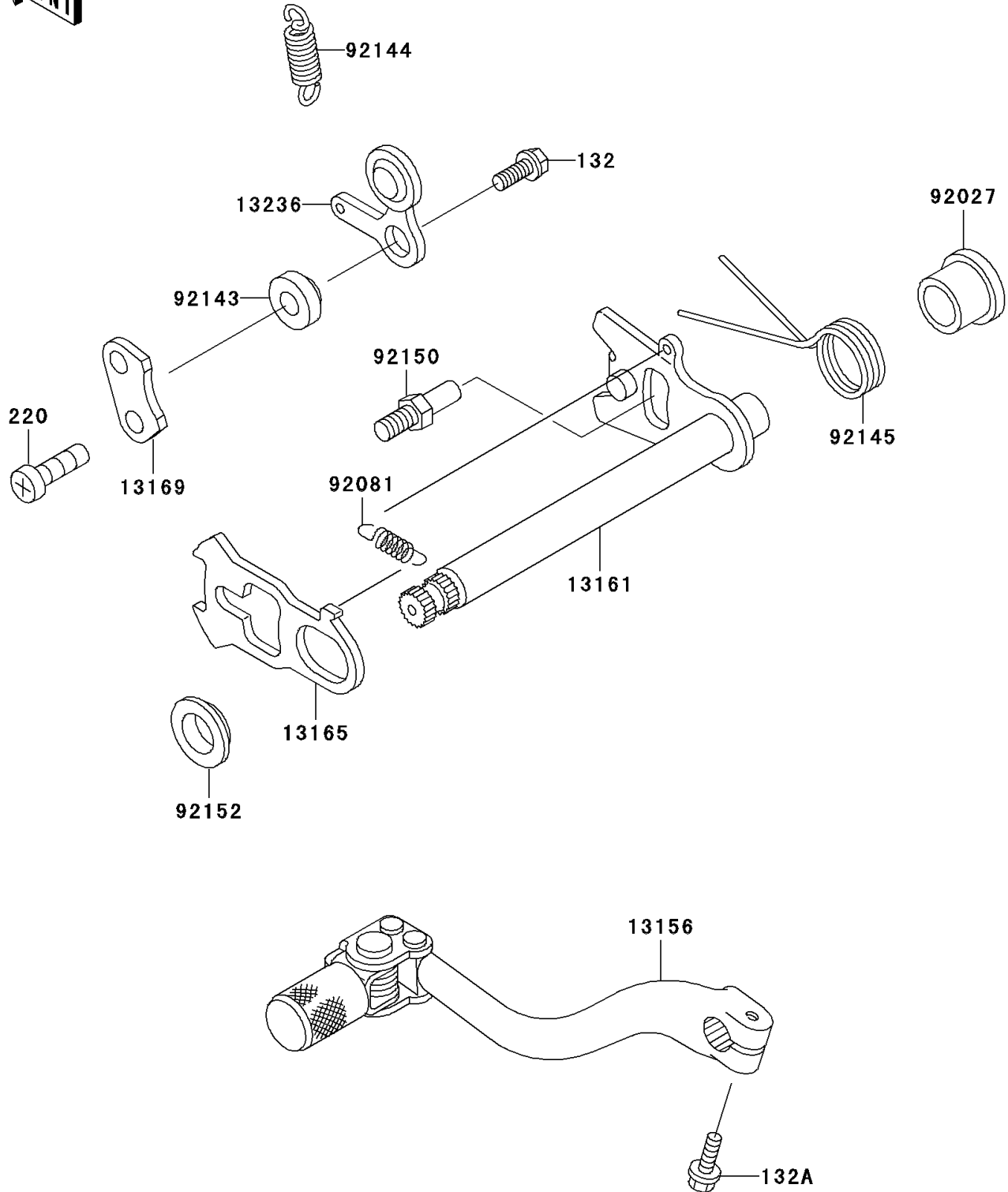

2001 KX500 PARTS LIST

Gear Change Mechanism

ITEM NAME	PART NUMBER	QUANTITY
BOLT-FLANGED-SMALL (Ref # 132)	132G0616	1
BOLT-FLANGED-SMALL (Ref # 132A)	132G0625	1
SCREW-PAN-CROS,6X14 (Ref # 220)	220B0614	2
LEVER-CHANGE,PEDAL (Ref # 13156)	13156-1347	1
LEVER-COMP-CHANGE SHAFT (Ref # 13161)	13161-1203	1
PAWL,CHANGE LEVER (Ref # 13165)	13165-1122	1
PLATE,CHANGE DRUM (Ref # 13169)	13169-012	1
LEVER-COMP,POSITION (Ref # 13236)	13236-1188	1
COLLAR (Ref # 92027)	92027-1946	1
SPRING,CHANGE LEVER (Ref # 92081)	92081-076	1
COLLAR (Ref # 92143)	92143-1055	1
SPRING (Ref # 92144)	92144-1382	1
SPRING (Ref # 92145)	92145-1368	1
BOLT,RETURN SPRING (Ref # 92150)	92150-1467	1
COLLAR (Ref # 92152)	92152-1075	1