

2000 KX500 PARTS DIAGRAM

Air Cleaner

E1130

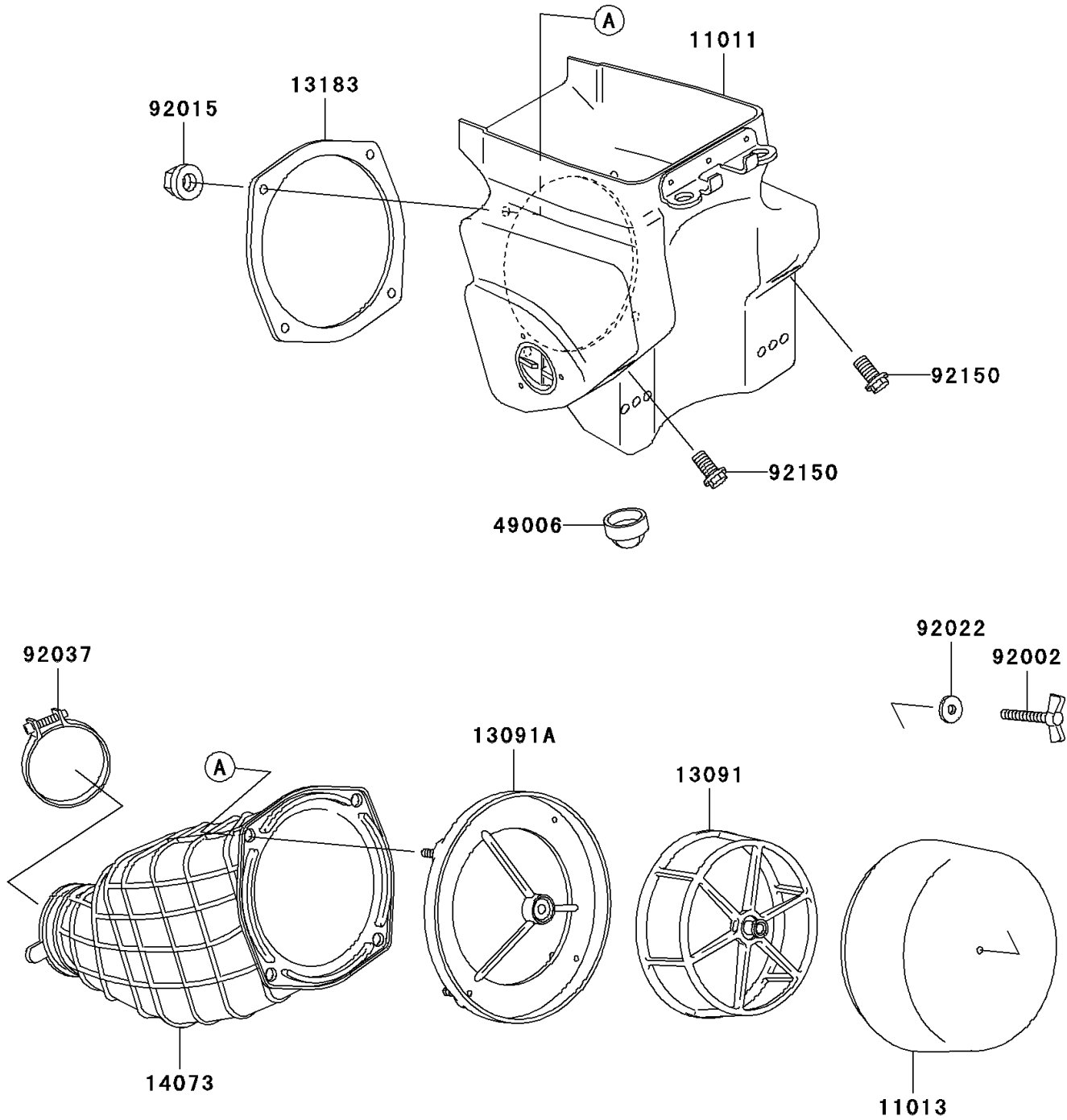

2000 KX500 PARTS LIST

Air Cleaner

| ITEM NAME | PART NUMBER | QUANTITY |
|----------------------------------|-------------|----------|
| CASE-AIR FILTER (Ref # 11011) | 11011-1304 | 1 |
| ELEMENT-AIR FILTER (Ref # 11013) | 11013-1198 | 1 |
| HOLDER,ELEMENT (Ref # 13091) | 13091-1454 | 1 |
| HOLDER (Ref # 13091A) | 13091-1951 | 1 |
| PLATE,DUCT FITTING (Ref # 13183) | 13183-1046 | 1 |
| DUCT (Ref # 14073) | 14073-1360 | 1 |
| BOOT (Ref # 49006) | 49006-1248 | 1 |
| BOLT,WING (Ref # 92002) | 92002-1719 | 1 |
| NUT,FLANGED,5MM (Ref # 92015) | 92015-1259 | 4 |
| WASHER,6.5X20X1.6 (Ref # 92022) | 92022-125 | 1 |
| CLAMP,AIR FILTER (Ref # 92037) | 92037-1409 | 1 |
| BOLT,FLANGED,6X16 (Ref # 92150) | 92150-1506 | 2 |