

# 2000 KX500 PARTS DIAGRAM

Cylinder Head/Cylinder

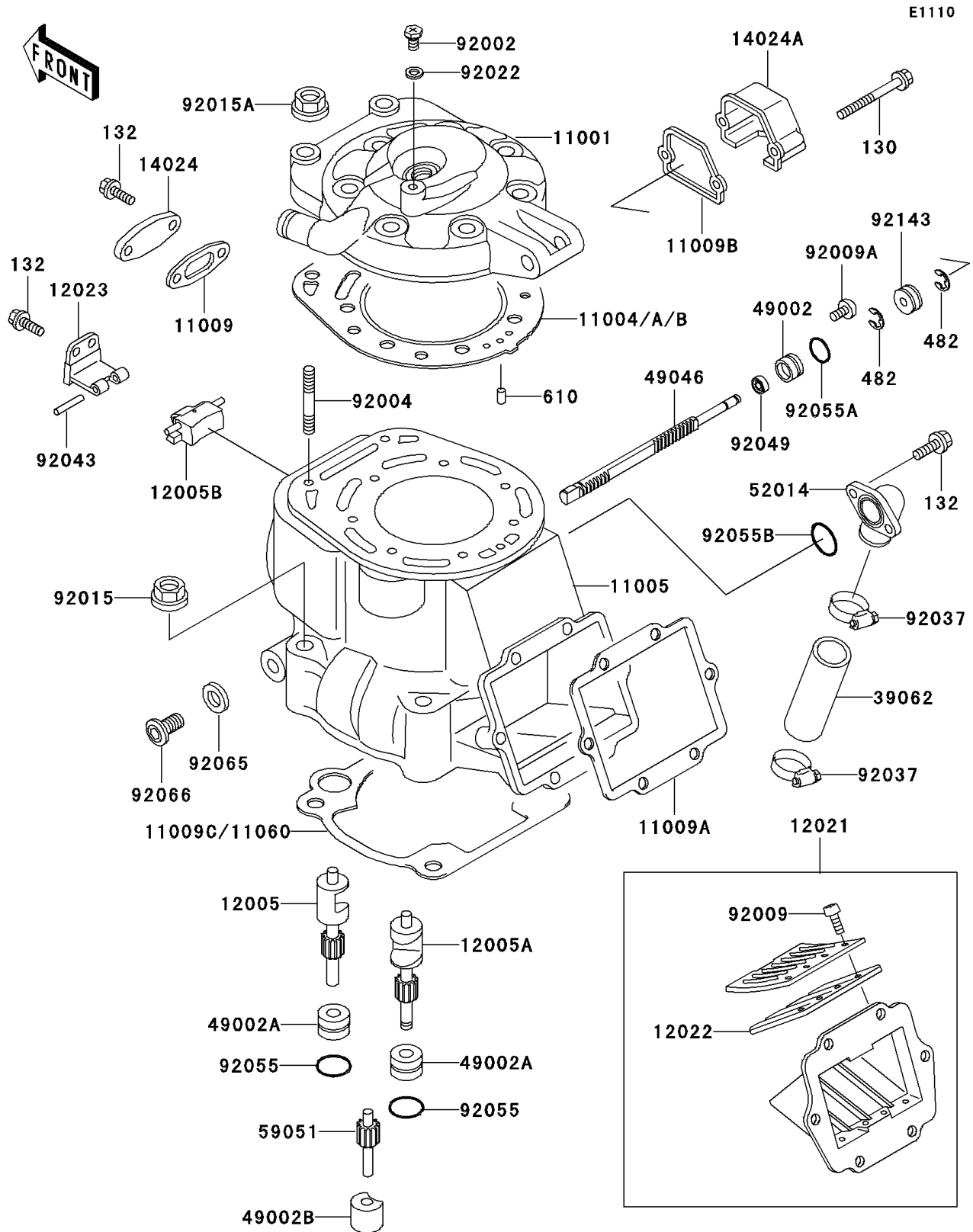

## 2000 KX500 PARTS LIST

### Cylinder Head/Cylinder

ITEM NAME	PART NUMBER	QUANTITY
HEAD-CYLINDER (Ref # 11001)	11001-1288	1
GASKET-HEAD,STEEL,T=0.2 (Ref # 11004)	11004-1187	1
GASKET-HEAD,STEEL,T=0.4 (Ref # 11004A)	11004-1209	1
GASKET-HEAD,T=1.0 (Ref # 11004B)	11004-1276	1
CYLINDER-ENGINE (Ref # 11005)	11005-1564	1
GASKET,VALVE COVER (Ref # 11009)	11009-1948	1
GASKET,REED VALVE (Ref # 11009A)	11009-1950	1
GASKET,GOVERNOR COVER (Ref # 11009B)	11009-1960	1
GASKET,CYLINDER BASE (Ref # 11060)	11060-1874	1
VALVE-EXHAUST,LH (Ref # 12005)	12005-1109	1
VALVE-EXHAUST,RH (Ref # 12005A)	12005-1110	1
VALVE-EXHAUST,CENTER (Ref # 12005B)	12005-1111	1
VALVE-ASSY-REED (Ref # 12021)	12021-1070	1
VALVE-REED (Ref # 12022)	12022-1017	2
HOLDER-VALVE,CENTER (Ref # 12023)	12023-1058	1
COVER,CENTER VALVE (Ref # 14024)	14024-1588	1
COVER,GOVERNOR (Ref # 14024A)	14024-1611	1
HOSE-COOLING,19X25X75 (Ref # 39062)	39062-1137	1
GUIDE-VALVE,ROD (Ref # 49002)	49002-1062	1
GUIDE-VALVE (Ref # 49002A)	49002-1093	2
GUIDE-VALVE,IDLE GEAR (Ref # 49002B)	49002-1094	1
ROD-GOVERNOR (Ref # 49046)	49046-1064	1
ELBOW (Ref # 52014)	52014-1084	1
GEAR-SPUR,IDLE (Ref # 59051)	59051-1205	1
BOLT,6X10 (Ref # 92002)	92002-1222	1
STUD,8X35 (Ref # 92004)	92004-1009	9
SCREW,3X6 (Ref # 92009)	92009-1371	8
SCREW,5X10 (Ref # 92009A)	92009-1502	1
NUT,FLANGED,10MM (Ref # 92015)	92015-077	4

## 2000 KX500 PARTS LIST

### Cylinder Head/Cylinder

ITEM NAME	PART NUMBER	QUANTITY
NUT,8MM (Ref # 92015A)	92015-1143	9
WASHER,6.2X11X1 (Ref # 92022)	92022-304	1
CLAMP,COOLING HOSE (Ref # 92037)	92037-1589	2
PIN,4X23.8 (Ref # 92043)	92043-1373	1
SEAL-OIL,RSO-5.5X11X4 (Ref # 92049)	92049-1206	1
RING-O,17.5X1.5 (Ref # 92055)	92055-022	2
RING-O (Ref # 92055A)	92055-025	1
RING-O,19.5X1.5 (Ref # 92055B)	92055-055	1
BOLT-FLANGED (Ref # 130)	130G0535	2
BOLT-FLANGED-SMALL (Ref # 132)	132G0616	6
CIRCLIP-TYPE-E,4MM (Ref # 482)	482J4000	2
ROLLER,4X8 (Ref # 610)	610A0408	1
GASKET,12.5X18X1,DRAIN PLUG (Ref # 92065)	92065-073	1
PLUG,12X10 (Ref # 92066)	92066-1222	1
COLLAR (Ref # 92143)	92143-1056	1