

## 1991 KX500 PARTS DIAGRAM

Radiator

E3032

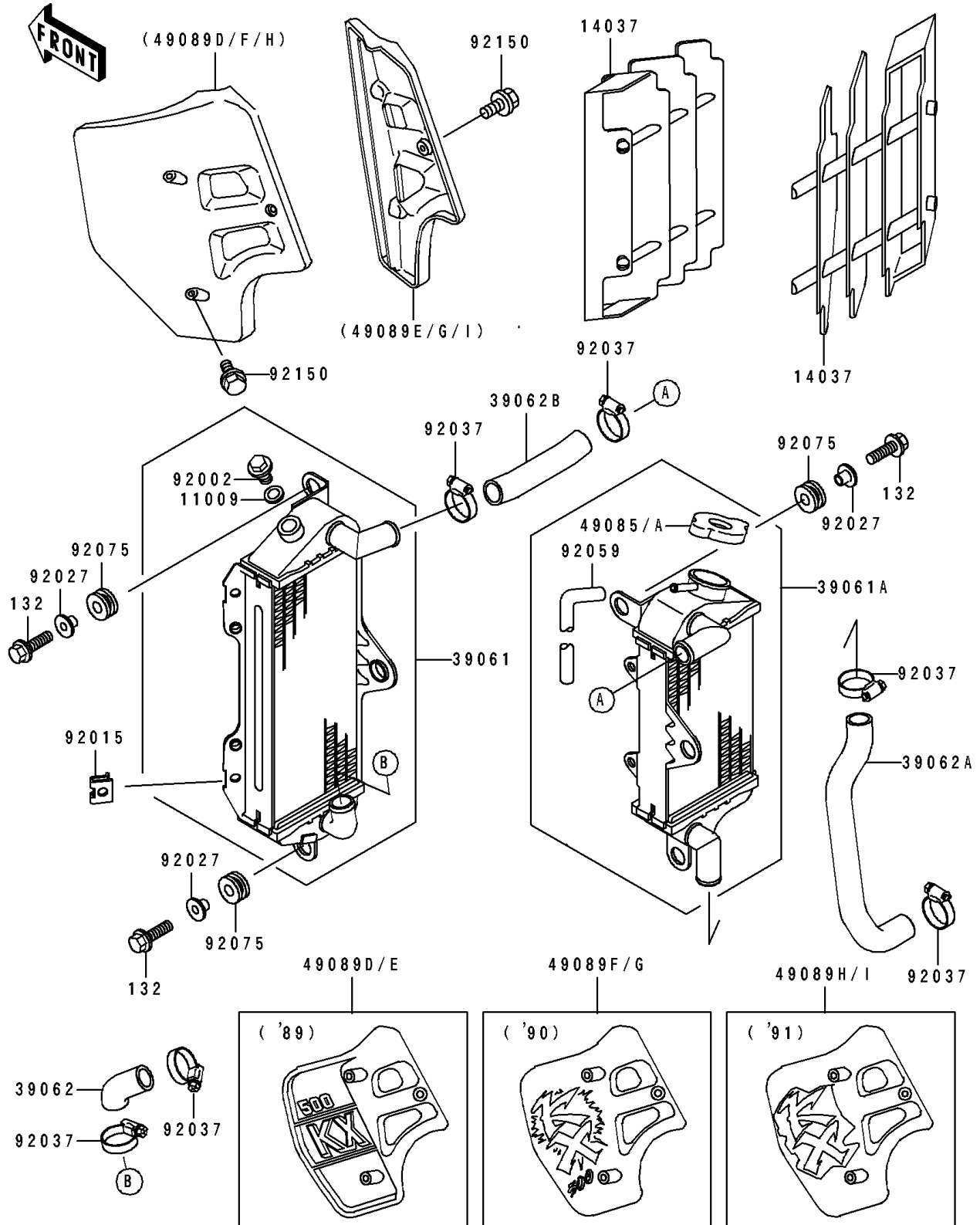

## 1991 KX500 PARTS LIST

Radiator

ITEM NAME	PART NUMBER	QUANTITY
GASKET,DRAIN BOLT (Ref # 11009)	11009-1152	1
SCREEN,LH,L.GREEN (Ref # 14037)	14037-1099-6W	1
RADIATOR-ASSY (Ref # 39061)	39061-1112	1
RADIATOR-ASSY (Ref # 39061A)	39061-1113	1
HOSE-COOLING,RADIATOR,LH (Ref # 39062)	39062-1138	1
HOSE-COOLING,RADIATOR,RH-PUMP (Ref # 39062A)	39062-1209	1
HOSE-COOLING,RADIATOR LH-RH (Ref # 39062B)	39062-1274	1
CAP-ASSY-PRESSURE (Ref # 49085)	49085-1003	1
CAP-ASSY-PRESSURE,P=1.6 (Ref # 49085A)	49085-1059	1
SHROUD-ENGINE,LH,L.GREEN (Ref # 49089H)	49089-5114-6W	1
SHROUD-ENGINE,RH,L.GREEN (Ref # 49089I)	49089-5115-6W	1
BOLT,RADIATOR DRAIN (Ref # 92002)	92002-1682	1
NUT (Ref # 92015)	92015-1487	1
COLLAR,L=11.1 (Ref # 92027)	92027-194	1
CLAMP,COOLING HOSE (Ref # 92037)	92037-1589	1
TUBE,5X9X800 (Ref # 92059)	92059-1383	1
DAMPER (Ref # 92075)	92075-209	1
BOLT,6X12 (Ref # 92150)	92150-1435	1
BOLT-FLANGED-SMALL (Ref # 132)	132G0620	1