

# 2007 KX250 PARTS DIAGRAM

## Frame Fittings

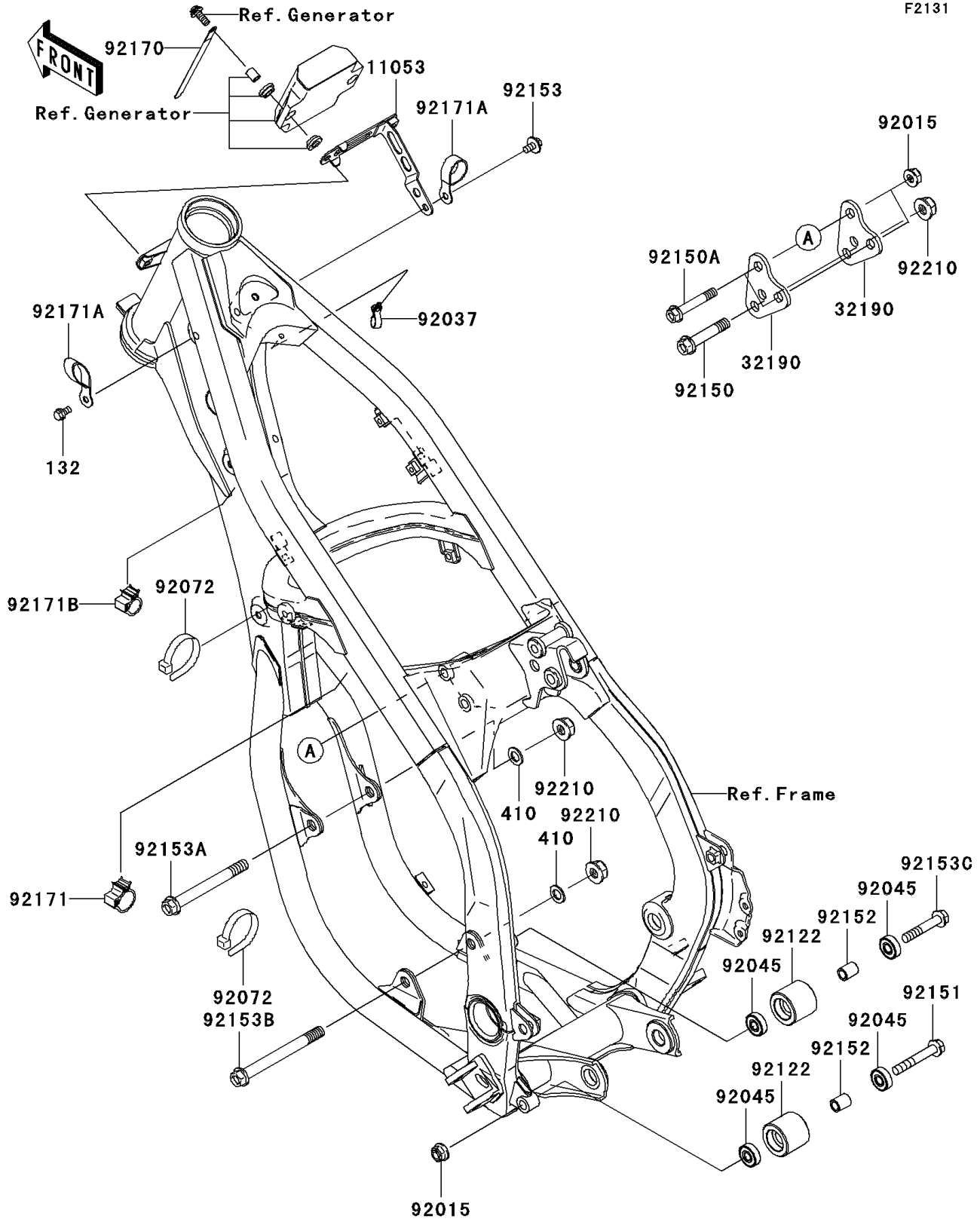

## 2007 KX250 PARTS LIST

### Frame Fittings

ITEM NAME	PART NUMBER	QUANTITY
BOLT-FLANGED-SMALL,6X10 (Ref # 132)	132L0610	1
WASHER-PLAIN-SMALL,10MM (Ref # 410)	410B1000	2
BRACKET,IGNITER (Ref # 11053)	11053-1629	1
BRACKET-ENGINE (Ref # 32190)	32190-0092	2
NUT,8MM (Ref # 92015)	92015-1432	3
CLAMP,SPEED,L=43 (Ref # 92037)	92037-1290	1
BEARING-BALL,608LLU/2A (Ref # 92045)	92045-1009	4
BAND,L=140 (Ref # 92072)	92072-1293	2
ROLLER,CHAIN GUIDE (Ref # 92122)	92122-0007	2
BOLT,FLANGED,10X50 (Ref # 92150)	92150-1125	1
BOLT,FLANGED,8X50 (Ref # 92150A)	92150-1214	2
BOLT,FLANGED,8X52 (Ref # 92151)	92151-1377	1
COLLAR,8.5X12.5X15.5 (Ref # 92152)	92152-0211	2
BOLT,6X12 (Ref # 92153)	92153-0503	1
BOLT,FLANGED,10X95 (Ref # 92153A)	92153-0613	1
BOLT,FLANGED,10X105 (Ref # 92153B)	92153-0614	1
BOLT,FLANGED,8X45 (Ref # 92153C)	92153-0751	1
CLAMP (Ref # 92170)	92170-1925	1
CLAMP,DIA=20 (Ref # 92171)	92171-0081	1
CLAMP (Ref # 92171A)	92171-1279	2
CLAMP,DIA=15 (Ref # 92171B)	92171-1424	1
NUT,LOCK,FLANGED,10MM (Ref # 92210)	92210-1080	3