

2005 KX250 PARTS DIAGRAM

Rear Suspension

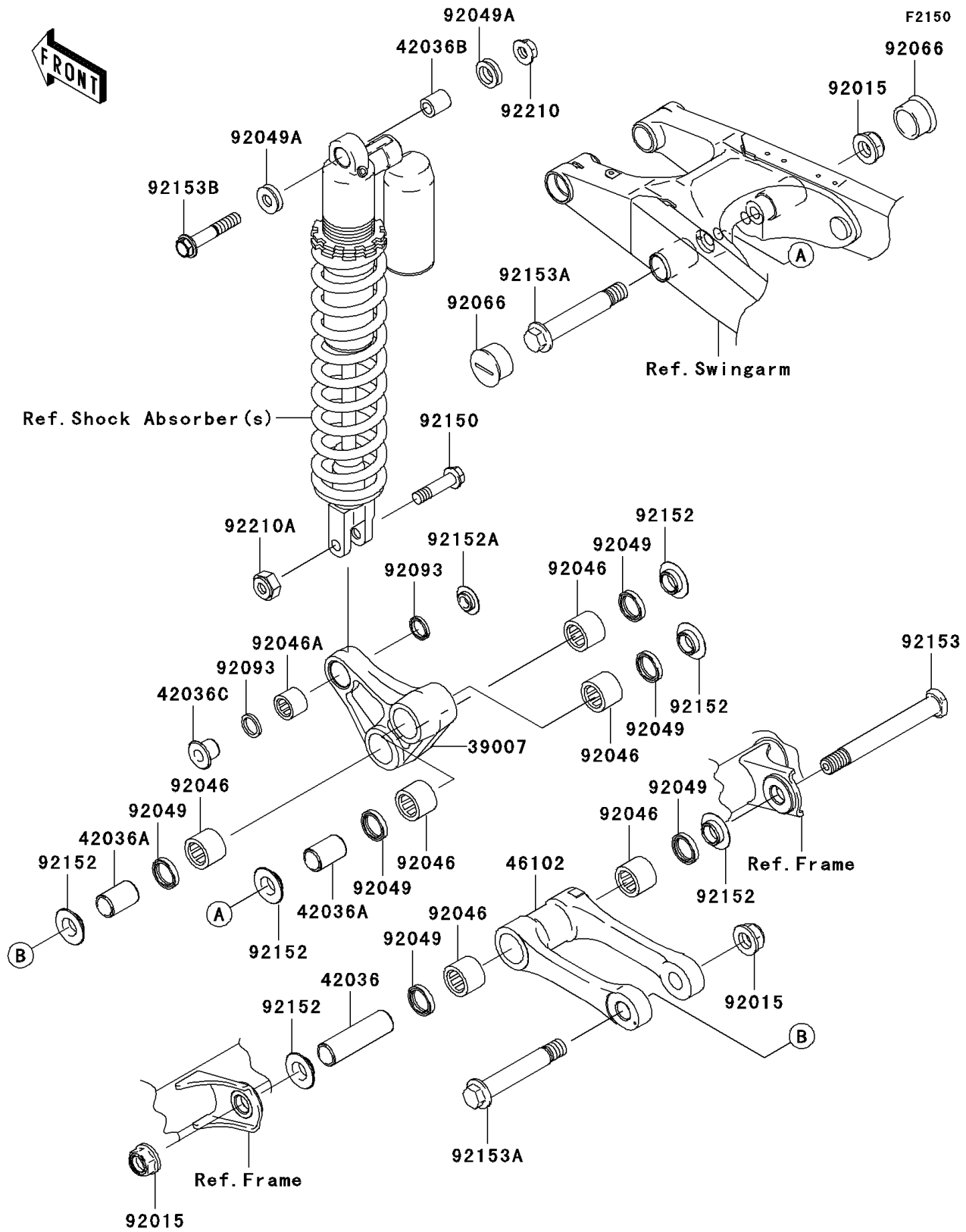

2005 KX250 PARTS LIST

Rear Suspension

ITEM NAME	PART NUMBER	QUANTITY
ARM-SUSP,UNI TRAK (Ref # 39007)	39007-0016	1
SLEEVE,15X20X80 (Ref # 42036)	42036-0014	1
SLEEVE,15X20X41.8 (Ref # 42036A)	42036-0015	2
SLEEVE,10X16X19 (Ref # 42036B)	42036-1248	1
SLEEVE (Ref # 42036C)	42036-1351	1
ROD,SUSPENSION (Ref # 46102)	46102-0060	1
NUT,FLANGED,14MM (Ref # 92015)	92015-1401	3
BEARING-NEEDLE,F-2016 (Ref # 92046)	92046-1151	6
BEARING-NEEDLE,7E-HVS16X22X12 (Ref # 92046A)	92046-1301	1
SEAL-OIL,HF020N3-A (Ref # 92049)	92049-0027	6
SEAL-OIL (Ref # 92049A)	92049-1330	2
PLUG,SWING ARM,F.BLACK (Ref # 92066)	92066-0026-6Z	2
SEAL (Ref # 92093)	92093-1436	2
BOLT,FLANGED,10X42 (Ref # 92150)	92150-1571	1
COLLAR (Ref # 92152)	92152-0108	6
COLLAR (Ref # 92152A)	92152-1139	1
BOLT,14MM,L=116 (Ref # 92153)	92153-0407	1
BOLT,14MM,L=92 (Ref # 92153A)	92153-0429	2
BOLT,FLANGED,10X56 (Ref # 92153B)	92153-0828	1
NUT,LOCK,FLANGED,10MM (Ref # 92210)	92210-1080	1
NUT,LOCK,10MM (Ref # 92210A)	92210-1184	1