

2021 Z H2 PARTS DIAGRAM

Generator

E1810

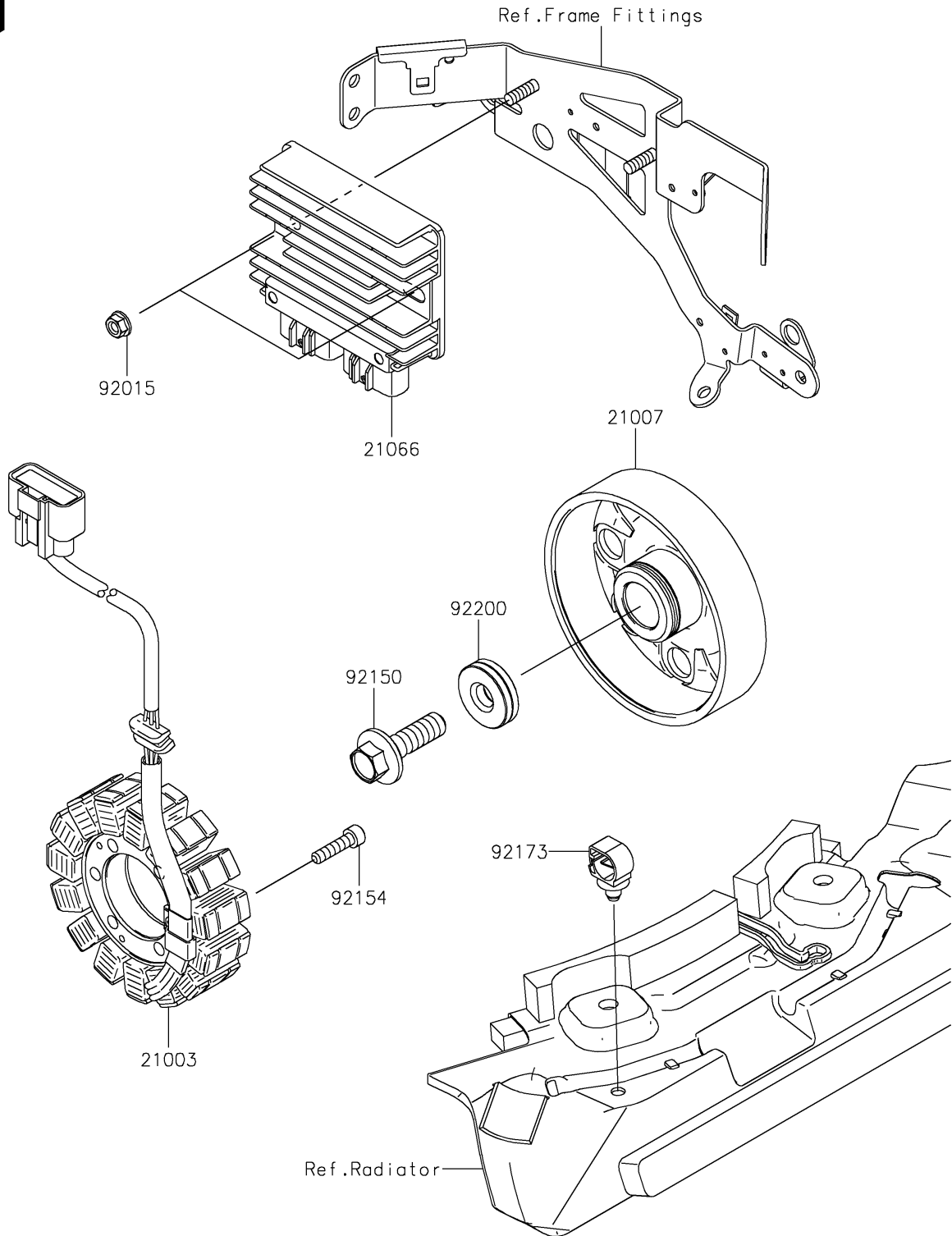

2021 Z H2 PARTS LIST

Generator

ITEM NAME	PART NUMBER	QUANTITY
STATOR (Ref # 21003)	21003-0197	1
ROTOR (Ref # 21007)	21007-0611	1
REGULATOR-VOLTAGE (Ref # 21066)	21066-0745	1
NUT,FLANGED,6MM (Ref # 92015)	92015-1367	2
BOLT,12X40 (Ref # 92150)	92150-1717	1
BOLT,SOCKET,6X25 (Ref # 92154)	92154-0477	4
CLAMP,12MM DIA. (Ref # 92173)	92173-0736	1
WASHER,12X34X9 (Ref # 92200)	92200-0369	1