

2018 NINJA® 1000 ABS PARTS DIAGRAM

Footrests

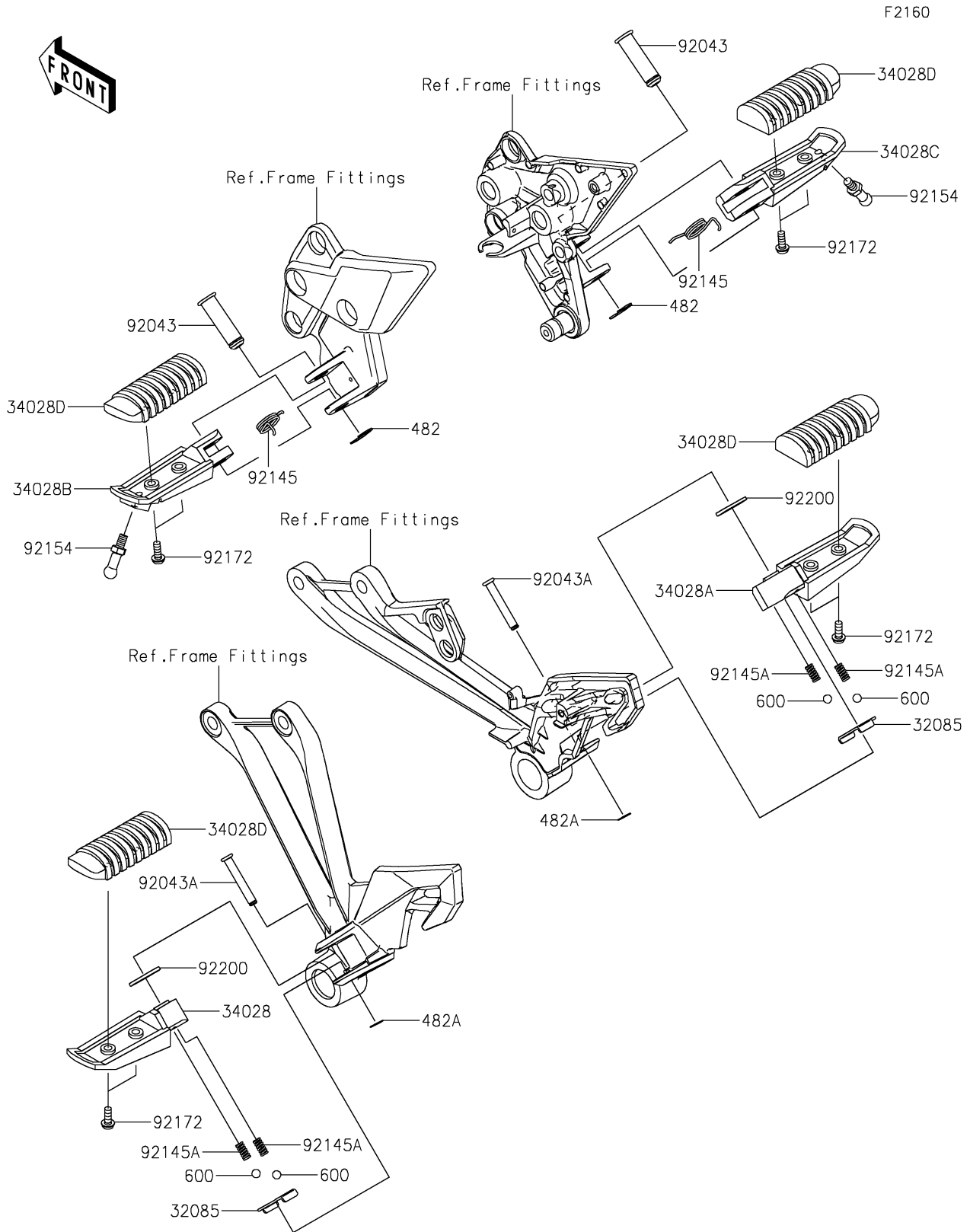

2018 NINJA® 1000 ABS PARTS LIST

Footrests

ITEM NAME	PART NUMBER	QUANTITY
STOPPER,REAR STEP (Ref # 32085)	32085-0047	2
STEP,RR,LH (Ref # 34028)	34028-0314	1
STEP,RR,RH (Ref # 34028A)	34028-0315	1
STEP,FR,LH (Ref # 34028B)	34028-0352	1
STEP,FR,RH (Ref # 34028C)	34028-0353	1
STEP,RUBBER (Ref # 34028D)	34028-1430	4
CIRCLIP-TYPE-E,10MM (Ref # 482)	482EA0100	2
CIRCLIP-TYPE-E (Ref # 482A)	482EA5000	2
BALL-STEEL,1/4 (Ref # 600)	600A0800	4
PIN,12X42.5 (Ref # 92043)	92043-1594	2
PIN,6X40 (Ref # 92043A)	92043-1595	2
SPRING,STEP RETURN,LH (Ref # 92145)	92145-0360	2
SPRING (Ref # 92145A)	92145-1319	4
BOLT,BANK SENSOR,6X10 (Ref # 92154)	92154-1854	2
SCREW,5X14 (Ref # 92172)	92172-0976	8
WASHER,16X26X2.3 (Ref # 92200)	92200-0043	2