

2001 KX250 PARTS DIAGRAM

Radiator

E3032

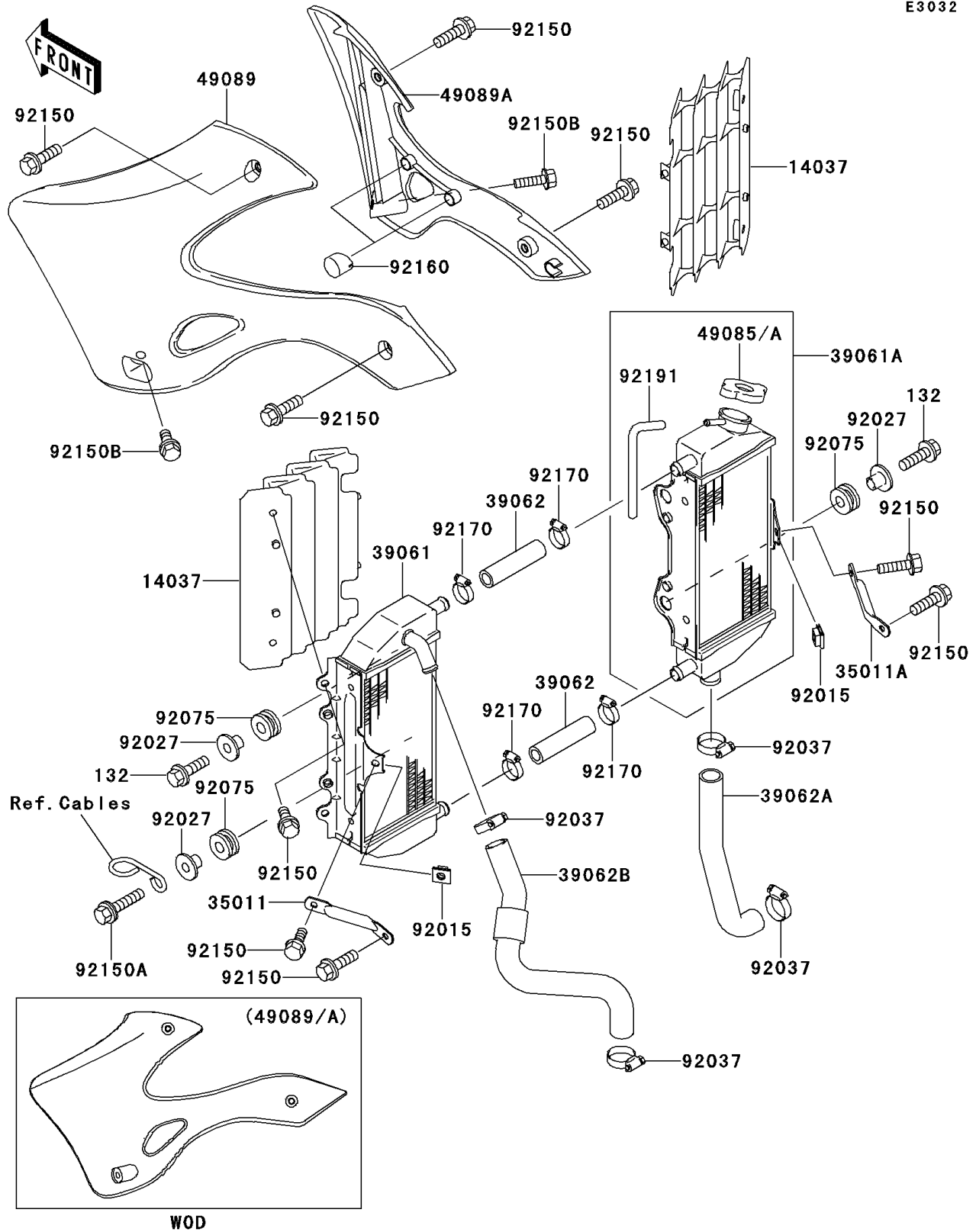

2001 KX250 PARTS LIST

Radiator

ITEM NAME	PART NUMBER	QUANTITY
BOLT-FLANGED-SMALL (Ref # 132)	132G0620	1
SCREEN,WHITE (Ref # 14037)	14037-1257-RZ	1
STAY,LH (Ref # 35011)	35011-1950	1
STAY,RH (Ref # 35011A)	35011-1951	1
RADIATOR-ASSY,LH (Ref # 39061)	39061-1262	1
RADIATOR-ASSY,RH (Ref # 39061A)	39061-1263	1
HOSE-COOLING,RADIATOR,LH-RH (Ref # 39062)	39062-1551	1
HOSE-COOLING,RADIATOR,RH-PUMP (Ref # 39062A)	39062-1555	1
HOSE-COOLING,HEAD-RADIATOR (Ref # 39062B)	39062-1787	1
CAP-ASSY-PRESSURE,P1.1 (Ref # 49085)	49085-1070	1
CAP-ASSY-PRESSURE,P1.6 (Ref # 49085A)	49085-1073	1
SHROUD-ENGINE,LH,L.GREEN (Ref # 49089)	49089-1140-6W	1
SHROUD-ENGINE,RH,L.GREEN (Ref # 49089A)	49089-1141-6W	1
NUT (Ref # 92015)	92015-1487	1
COLLAR,L=11.1 (Ref # 92027)	92027-194	1
CLAMP,COOLING HOSE (Ref # 92037)	92037-1589	1
DAMPER (Ref # 92075)	92075-209	1
BOLT,6X12 (Ref # 92150)	92150-1435	1
BOLT,FLANGED,6X25 (Ref # 92150A)	92150-1507	1
BOLT,6X20 (Ref # 92150B)	92150-1801	1
DAMPER (Ref # 92160)	92160-1949	1
CLAMP (Ref # 92170)	92170-1283	1
TUBE,6X9X700 (Ref # 92191)	92191-1211	1