

2021 VULCAN® 900 CLASSIC LT PARTS DIAGRAM

Chassis Electrical Equipment

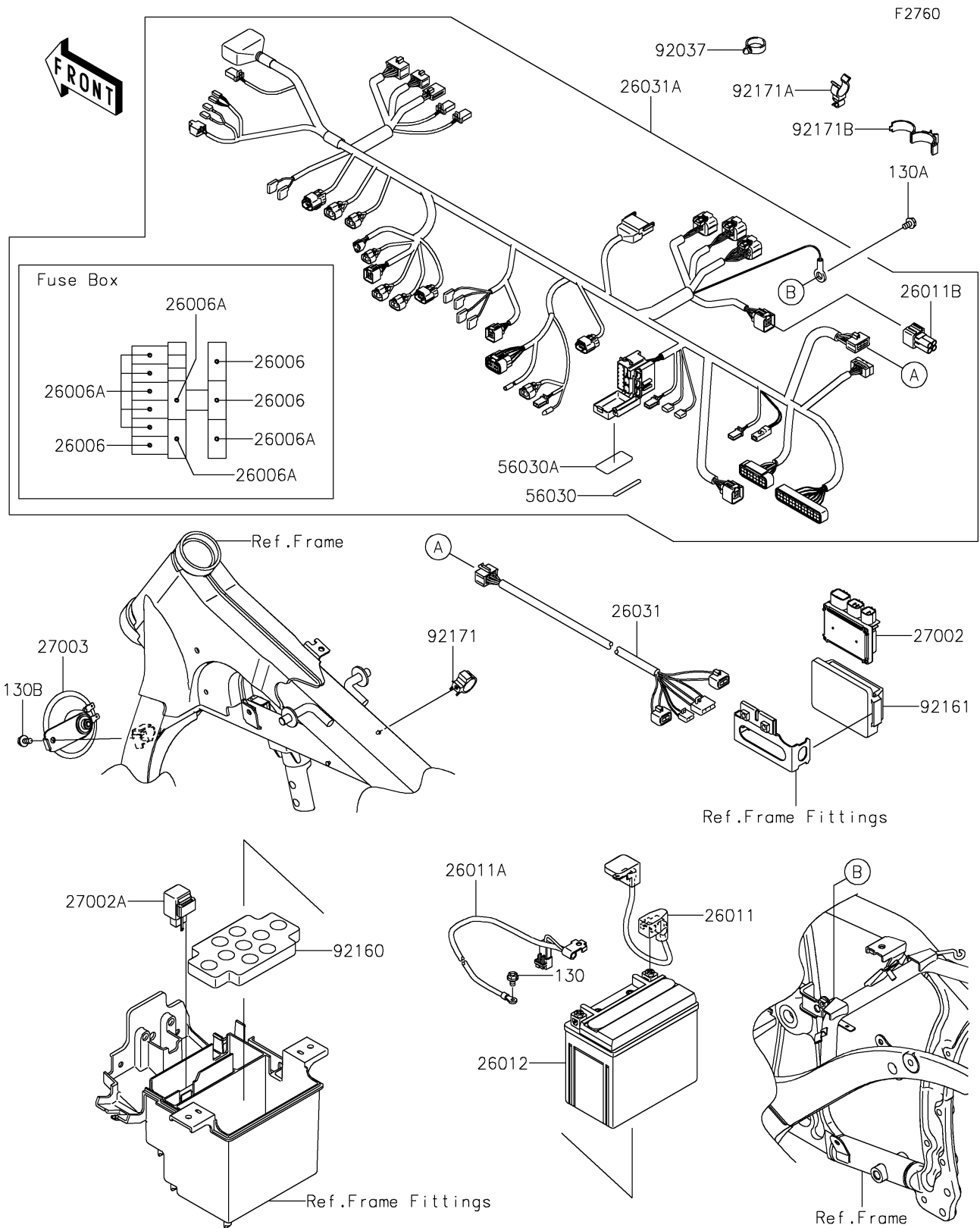

2021 VULCAN® 900 CLASSIC LT PARTS LIST

Chassis Electrical Equipment

ITEM NAME	PART NUMBER	QUANTITY
-----------	-------------	----------