

2000 KX250 PARTS DIAGRAM

Footrests

F2160

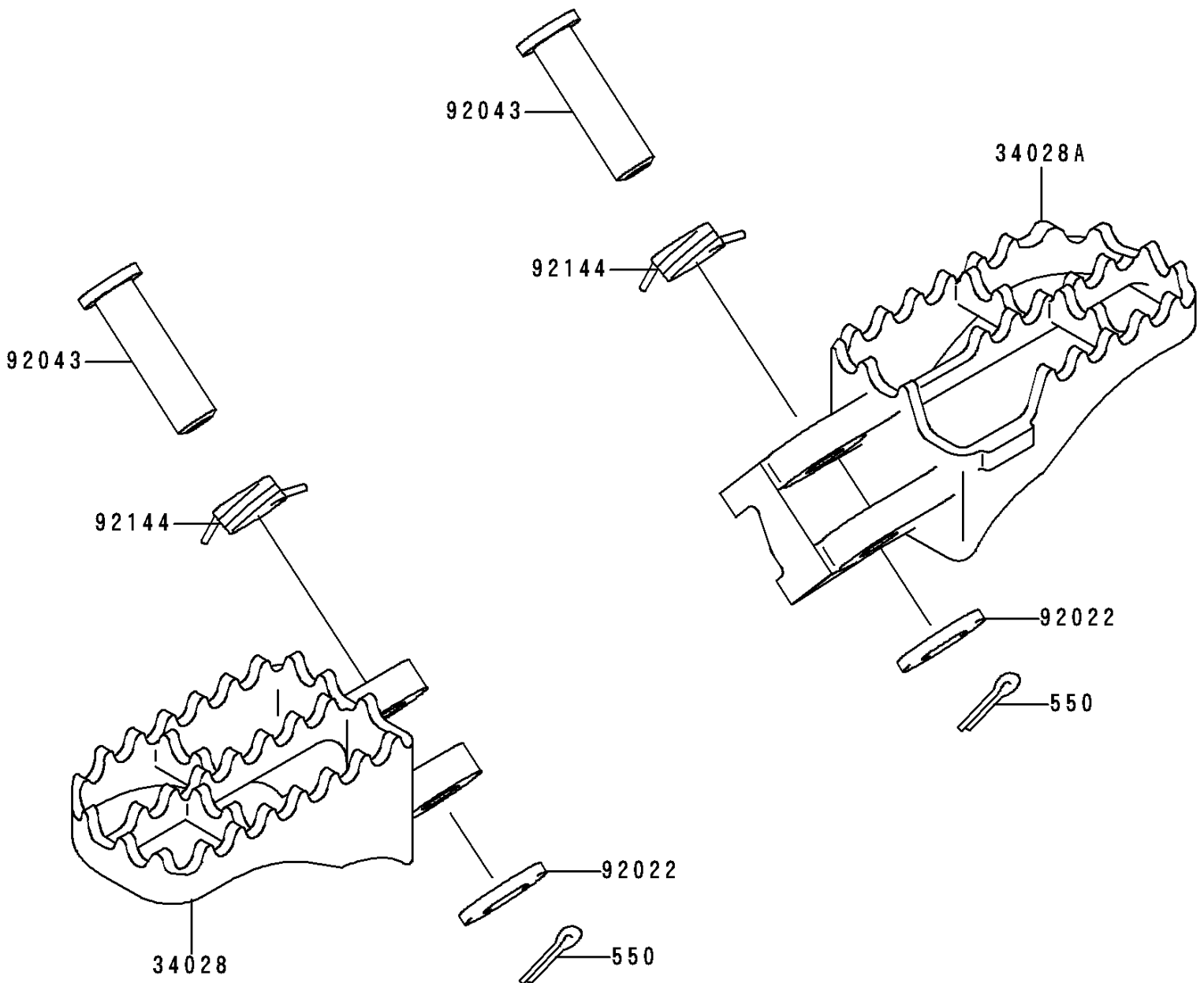

2000 KX250 PARTS LIST

Footrests

ITEM NAME	PART NUMBER	QUANTITY
PIN-COTTER,3.0X20 (Ref # 550)	550S3020	2
STEP,LH,SILVER (Ref # 34028)	34028-1475-CE	1
STEP,RH,SILVER (Ref # 34028A)	34028-1476-CE	1
WASHER,10.2X16X1 (Ref # 92022)	92022-1829	2
PIN,10X49.5 (Ref # 92043)	92043-1564	2
SPRING,STEP (Ref # 92144)	92144-1951	2