

# 2018 VULCAN® 900 CLASSIC PARTS DIAGRAM

Side Covers/Chain Cover

F2610

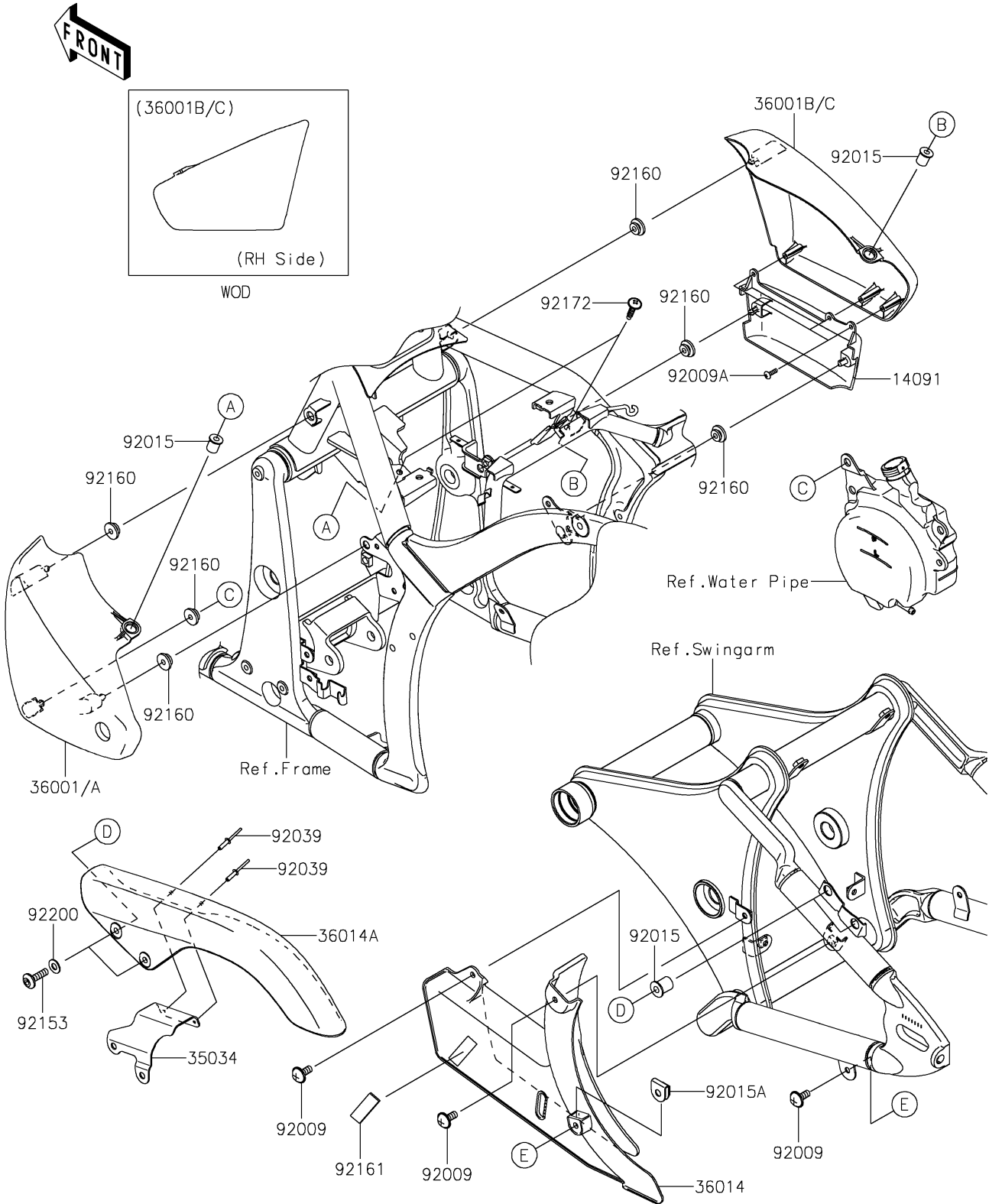

## 2018 VULCAN® 900 CLASSIC PARTS LIST

### Side Covers/Chain Cover

ITEM NAME	PART NUMBER	QUANTITY
COVER,SIDE COVER,RH (Ref # 14091)	14091-0641	1
REINFORCE (Ref # 35034)	35034-0082	1
COVER-SIDE,LH,M.M.C.GRAY (Ref # 36001)	36001-0081-51B	1
COVER-SIDE,RH,M.M.C.GRAY (Ref # 36001B)	36001-0082-51B	1
CASE-CHAIN,LWR (Ref # 36014)	36014-0031	1
CASE-CHAIN,UPP (Ref # 36014A)	36014-0052	1
SCREW,6X14 (Ref # 92009)	92009-1662	3
SCREW,TAPPING,4X14 (Ref # 92009A)	92009-1792	3
NUT (Ref # 92015)	92015-1700	4
NUT,CLIP,6MM (Ref # 92015A)	92015-1904	1
RIVET (Ref # 92039)	92039-1251	2
BOLT,SOCKET,6X22 (Ref # 92153)	92153-1356	2
DAMPER (Ref # 92160)	92160-1613	6
DAMPER (Ref # 92161)	92161-0124	1
SCREW,6X26 (Ref # 92172)	92172-0137	2
WASHER,6.5X14X1 (Ref # 92200)	92200-1388	2