

2004 KX125 PARTS DIAGRAM

Cylinder Head/Cylinder

E1110

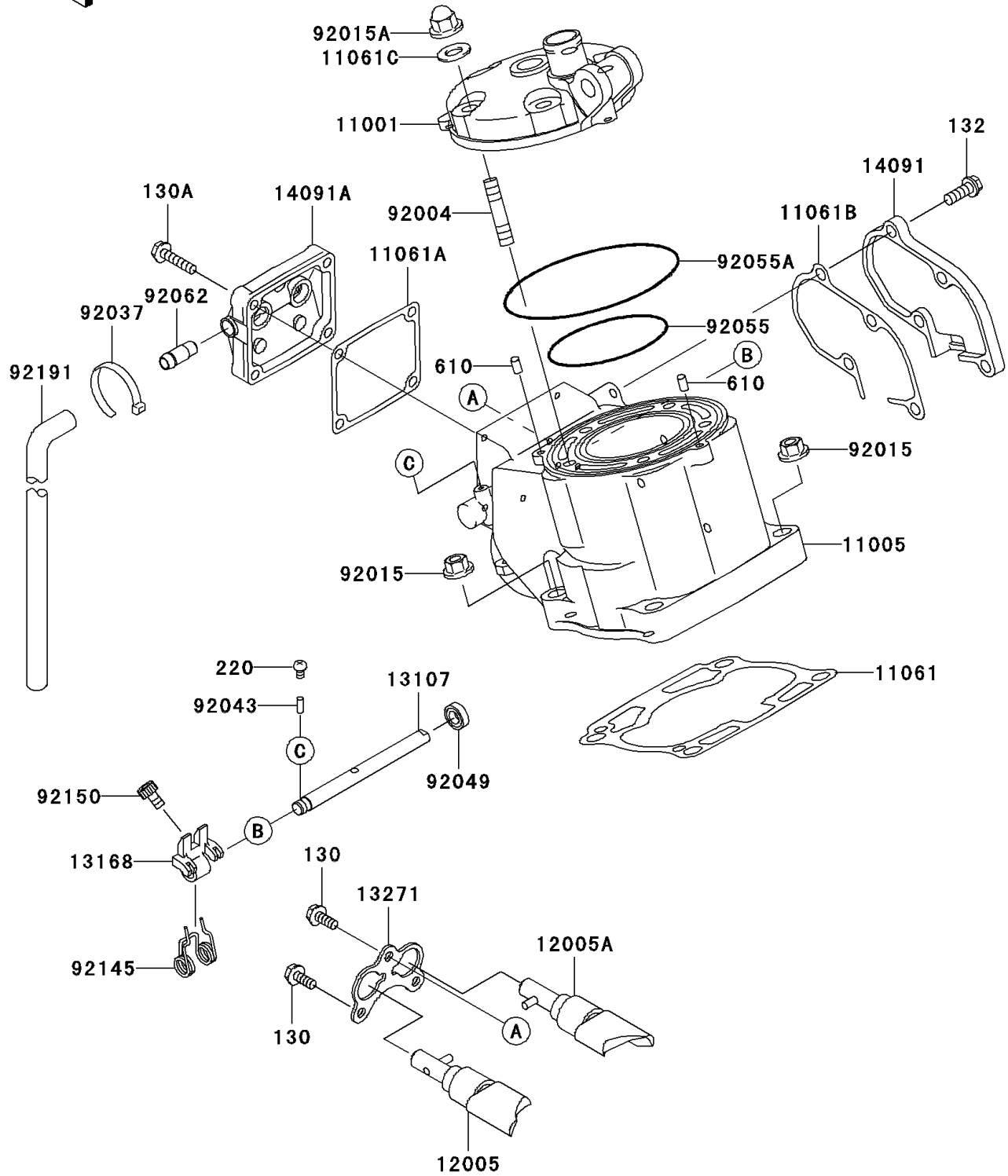

2004 KX125 PARTS LIST

Cylinder Head/Cylinder

ITEM NAME	PART NUMBER	QUANTITY
BOLT-FLANGED (Ref # 130)	130G0512	1
BOLT-FLANGED,CENTER COVER (Ref # 130A)	130G0522	1
BOLT-FLANGED-SMALL (Ref # 132)	132G0616	1
SCREW-PAN-CROS,4X6 (Ref # 220)	220B0406	1
ROLLER,4X8 (Ref # 610)	610A0408	1
HEAD-CYLINDER (Ref # 11001)	11001-0013	1
CYLINDER-ENGINE (Ref # 11005)	11005-0013	1
GASKET,T=0.37 (Ref # 11061)	11061-0039	1
GASKET,CENTER COVER (Ref # 11061A)	11061-1131	1
GASKET,RIGHT COVER (Ref # 11061B)	11061-1132	1
GASKET,HEAD (Ref # 11061C)	11061-1133	1
VALVE-EXHAUST,LH (Ref # 12005)	12005-0012	1
VALVE-EXHAUST,RH (Ref # 12005A)	12005-0014	1
SHAFT (Ref # 13107)	13107-1500	1
LEVER (Ref # 13168)	13168-1747	1
PLATE (Ref # 13271)	13271-1823	1
COVER,RH (Ref # 14091)	14091-0077	1
COVER,CNT (Ref # 14091A)	14091-0173	1
STUD,8X28 (Ref # 92004)	92004-1110	1
NUT,8MM (Ref # 92015)	92015-1143	1
NUT,CAP,8MM (Ref # 92015A)	92015-1151	1
CLAMP (Ref # 92037)	92037-1173	1
PIN,3X8.5 (Ref # 92043)	92043-0033	1
SEAL-OIL,SD088144 (Ref # 92049)	92049-1238	1
RING-O,IN (Ref # 92055)	92055-1678	1
RING-O,OUT (Ref # 92055A)	92055-1679	1
NOZZLE (Ref # 92062)	92062-3711	1
SPRING (Ref # 92145)	92145-1491	1
BOLT,SOCKET,4X8 (Ref # 92150)	92150-1888	1

2004 KX125 PARTS LIST

Cylinder Head/Cylinder

ITEM NAME	PART NUMBER	QUANTITY
TUBE,5.8X10.8X225 (Ref # 92191)	92191-1692	1