

2015 MULE PRO-FXT™ EPS LE PARTS DIAGRAM

Crankshaft/Piston(s)

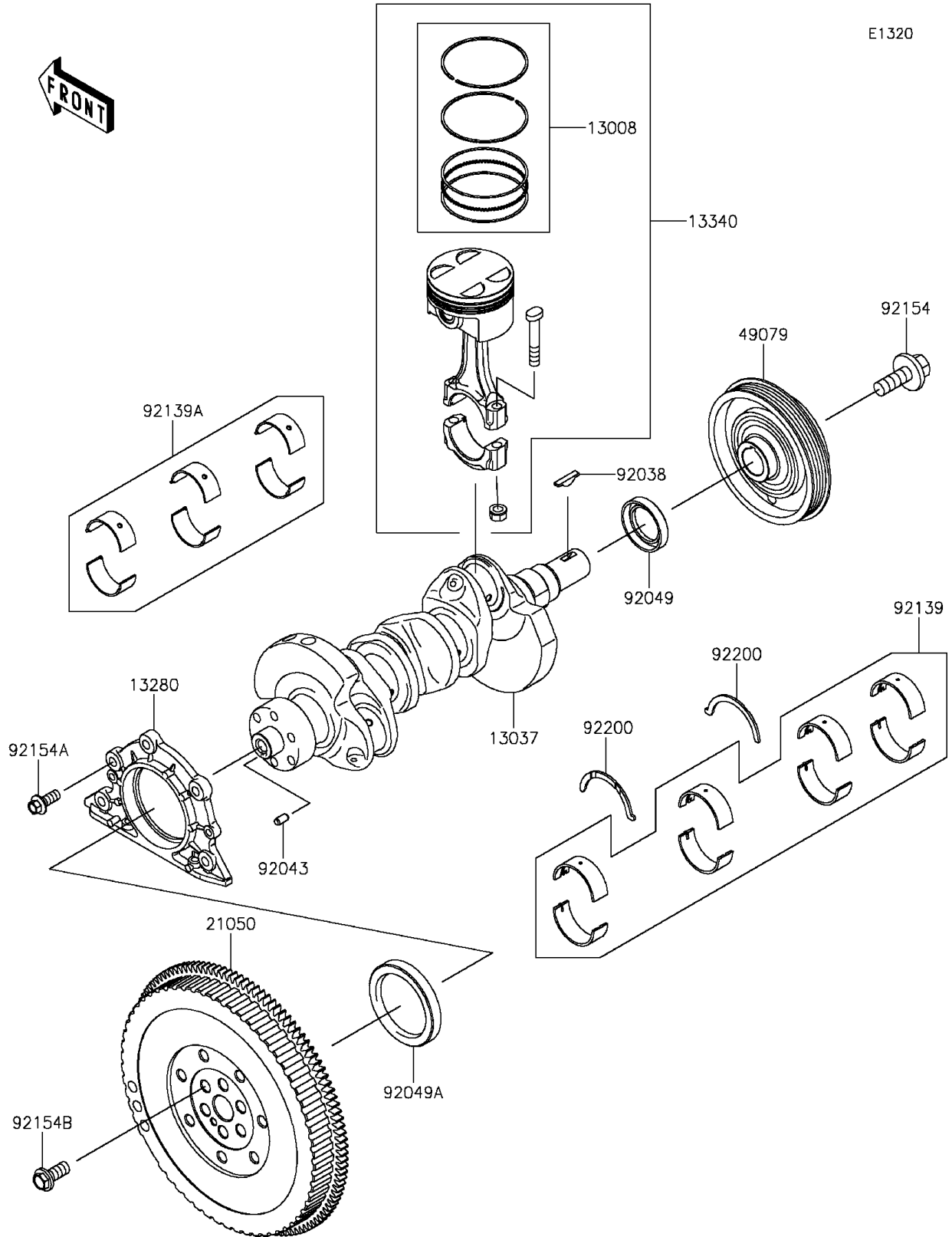

2015 MULE PRO-FXT™ EPS LE PARTS LIST

Crankshaft/Piston(s)

ITEM NAME	PART NUMBER	QUANTITY
-----------	-------------	----------