

2020 MULE PRO-FXT™ RANCH EDITION PARTS DIAGRAM

Rear Hubs/Brakes

F2240

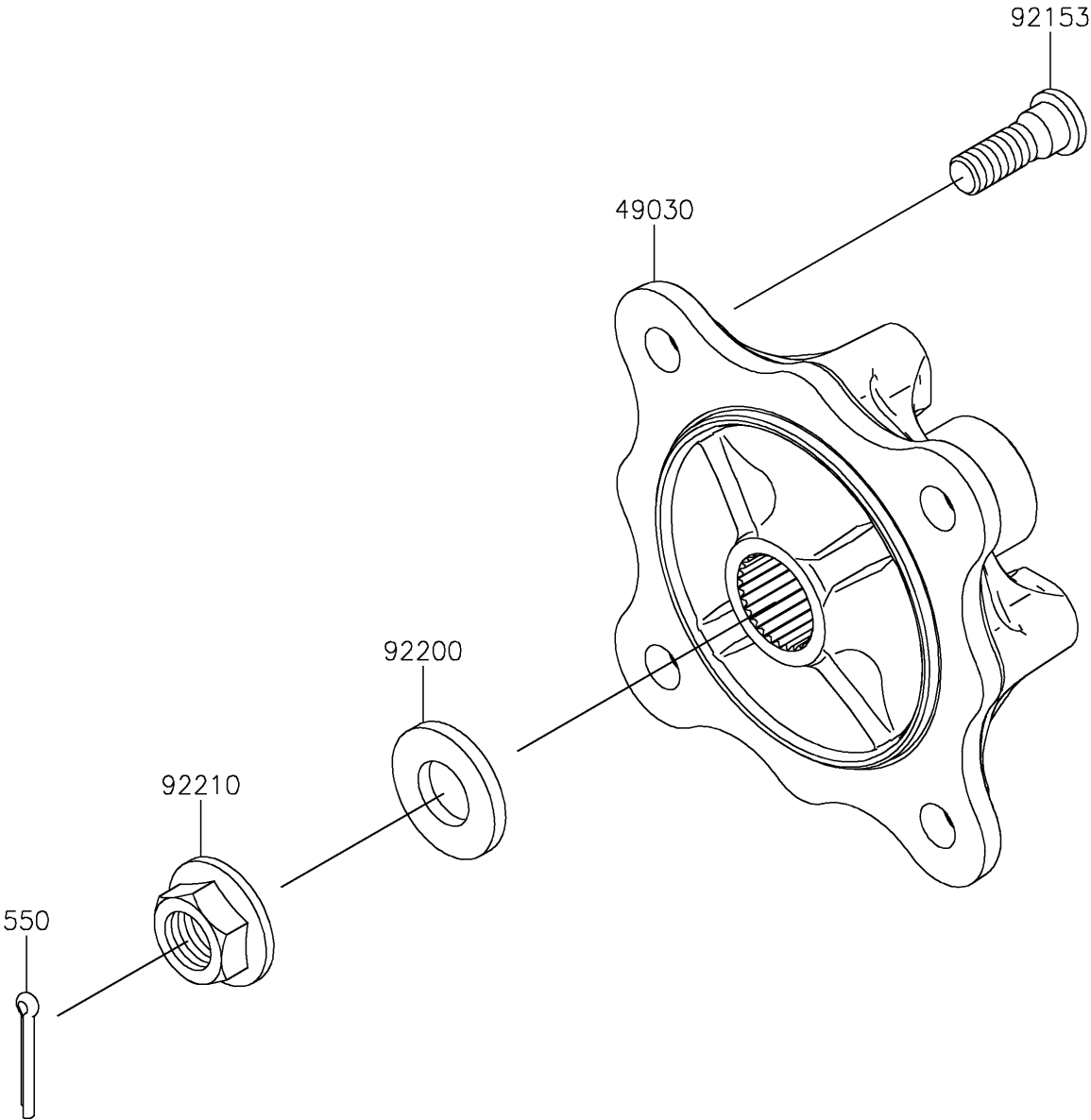

2020 MULE PRO-FXT™ RANCH EDITION PARTS LIST

Rear Hubs/Brakes

ITEM NAME	PART NUMBER	QUANTITY
HUB,RR (Ref # 49030)	49030-0049	1
PIN-COTTER,4.0X30 (Ref # 550)	550AA4030	1
BOLT,12MM (Ref # 92153)	92153-1915	1
WASHER,20.3X41X4.5 (Ref # 92200)	92200-0921	1
NUT,FLANGED,20MM (Ref # 92210)	92210-2093	1