

## 2020 MULE PRO-FXT™ RANCH EDITION PARTS DIAGRAM

Wheels/Tires

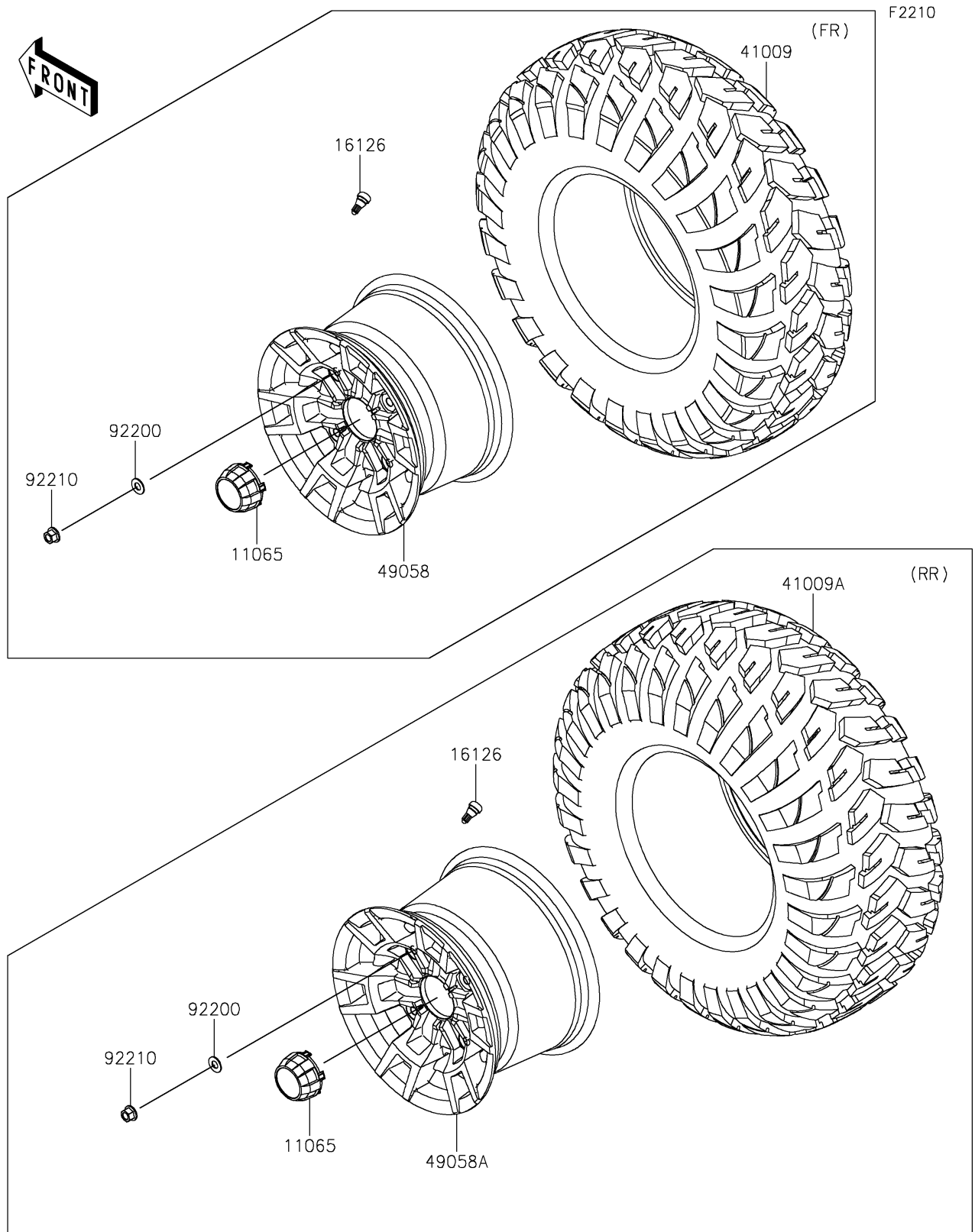

## 2020 MULE PRO-FXT™ RANCH EDITION PARTS LIST

Wheels/Tires

| ITEM NAME                                       | PART NUMBER    | QUANTITY |
|---|----------------|----------|
| CAP,WHEEL,F.BLACK (Ref # 11065)                 | 11065-0893-6Z  | 1        |
| VALVE (Ref # 16126)                             | 16126-4001     | 1        |
| TIRE,FR,26X9.00R12 4PR,FRONTIER (Ref # 41009)   | 41009-0567     | 1        |
| TIRE,RR,26X11.00R12 4PR,FRONTIER (Ref # 41009A) | 41009-0568     | 1        |
| WHEEL,FR,12X7.0AT,AL,BLACK (Ref # 49058)        | 49058-0625-31D | 1        |
| WHEEL,RR,12X8.0AT,AL,BLACK (Ref # 49058A)       | 49058-0626-31D | 1        |
| WASHER,12.1X25X1.6 (Ref # 92200)                | 92200-0455     | 1        |
| NUT,12MM (Ref # 92210)                          | 92210-0603     | 1        |