

2018 MULE PRO-FXT™ EPS LE PARTS DIAGRAM

Muffler(s)

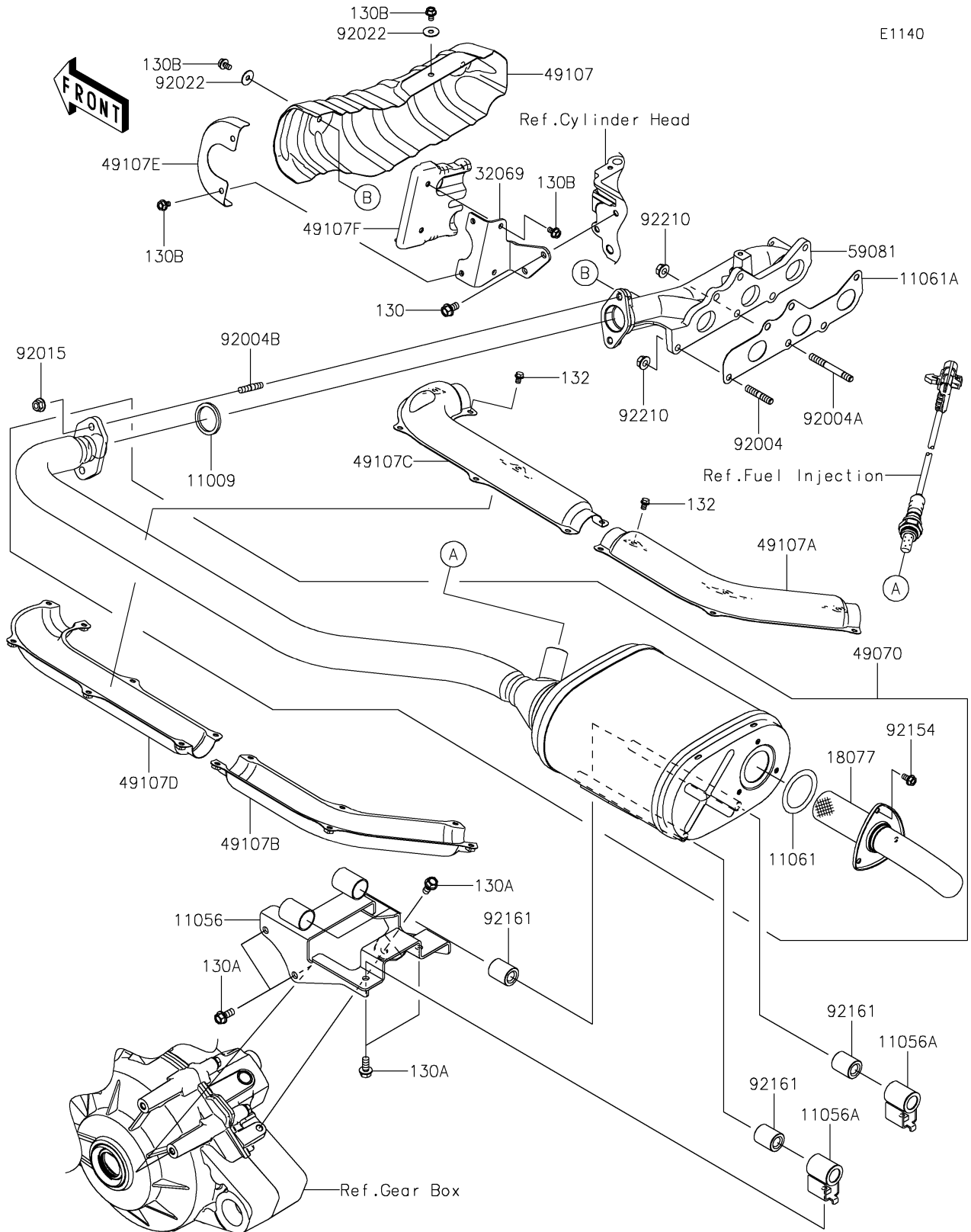

2018 MULE PRO-FXT™ EPS LE PARTS LIST

Muffler(s)

ITEM NAME	PART NUMBER	QUANTITY
GASKET,EXHAUST HOLDER (Ref # 11009)	11009-1894	1
BRACKET,MUFFLER MOUNT (Ref # 11056)	11056-4394	1
BRACKET (Ref # 11056A)	11056-4440	2
GASKET,EXHAUST PIPE (Ref # 11061)	11061-0013	1
GASKET (Ref # 11061A)	11061-1186	1
BOLT-FLANGED,8X14 (Ref # 130)	130BA0814	2
BOLT-FLANGED,8X18 (Ref # 130A)	130BA0818	5
BOLT-FLANGED,6X10 (Ref # 130B)	130BD0610	7
BOLT-FLANGED-SMALL,6X8 (Ref # 132)	132BD0608	13
ARRESTER-SPARK (Ref # 18077)	18077-0044	1
BRACKET-MUFFLER (Ref # 32069)	32069-0894	1
MUFFLER-COMP (Ref # 49070)	49070-0852	1
COVER-EXHAUST PIPE (Ref # 49107)	49107-0767	1
COVER-EXHAUST PIPE,RR,UPP (Ref # 49107A)	49107-0771	1
COVER-EXHAUST PIPE,RR,LWR (Ref # 49107B)	49107-0772	1
COVER-EXHAUST PIPE,FR,UPP (Ref # 49107C)	49107-0773	1
COVER-EXHAUST PIPE,FR,LWR (Ref # 49107D)	49107-0774	1
COVER-EXHAUST PIPE (Ref # 49107E)	49107-0838	1
COVER-EXHAUST PIPE (Ref # 49107F)	49107-0839	1
MANIFOLD-EXHAUST (Ref # 59081)	59081-0235	1
STUD (Ref # 92004)	92004-0735	5
STUD (Ref # 92004A)	92004-0736	1
STUD,8X25 (Ref # 92004B)	92004-1214	2
NUT,8MM (Ref # 92015)	92015-1402	2
WASHER,PLAIN,6.5X20X1 (Ref # 92022)	92022-165	3
BOLT,FLANGED,6X12 (Ref # 92154)	92154-0852	3
DAMPER (Ref # 92161)	92161-0961	4
NUT (Ref # 92210)	92210-0944	6