

2019 MULE PRO-DX™ EPS DIESEL PARTS DIAGRAM

Cylinder Head Cover

E1112

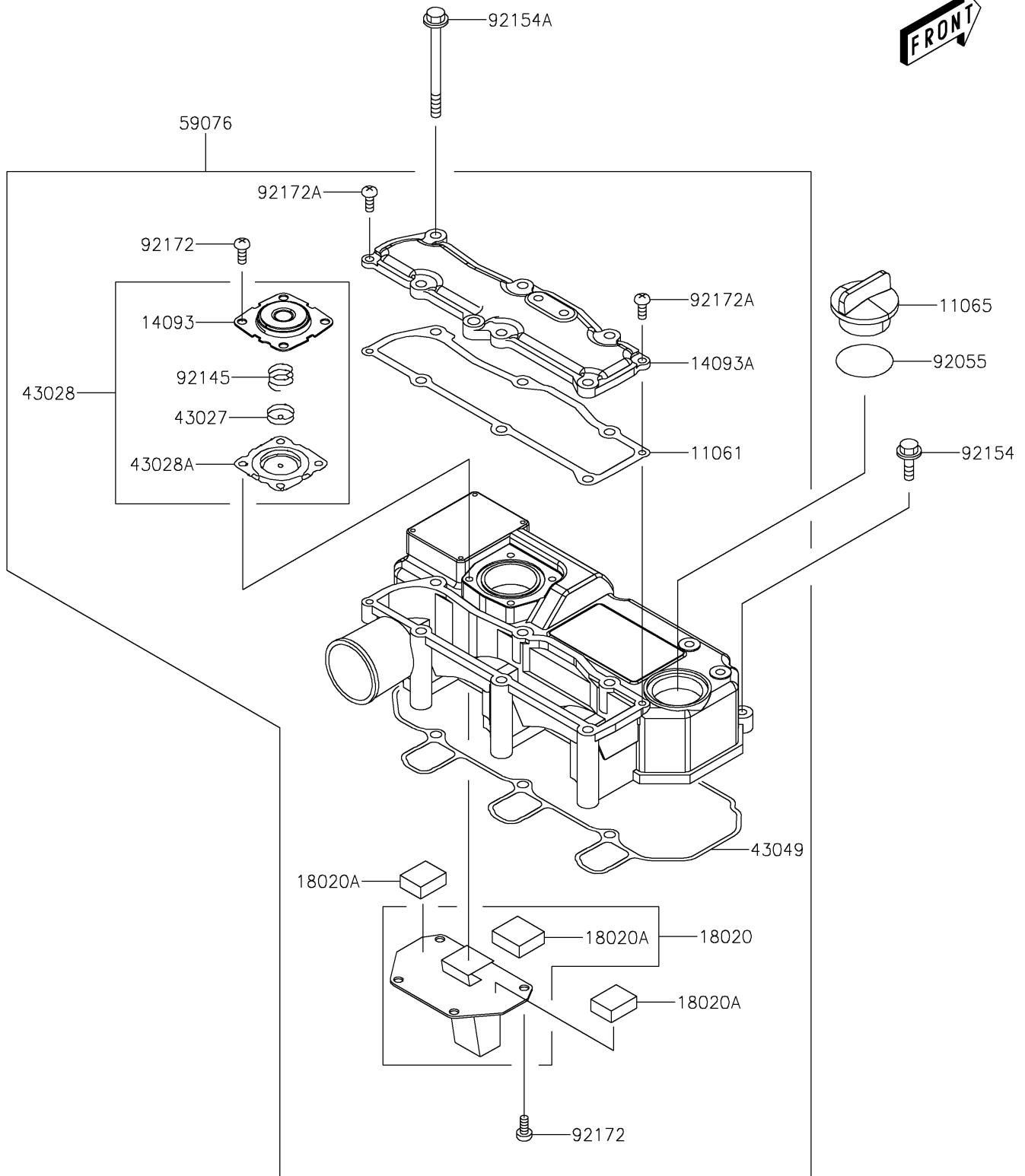

2019 MULE PRO-DX™ EPS DIESEL PARTS LIST

Cylinder Head Cover

ITEM NAME	PART NUMBER	QUANTITY
GASKET,INTAKE MANIFOLD COVER (Ref # 11061)	11061-1193	1
CAP,FILLER (Ref # 11065)	11065-0943	1
COVER,DIAPHRAGM (Ref # 14093)	14093-0442	1
COVER,INTAKE MANIFOLD (Ref # 14093A)	14093-0444	1
BAFFLE,PLATE (Ref # 18020)	18020-0723	1
BAFFLE,BREATHER (Ref # 18020A)	18020-0724	1
PLATE-DIAPHRAGM (Ref # 43027)	43027-0009	1
DIAPHRAGM,ASSY (Ref # 43028)	43028-0019	1
DIAPHRAGM (Ref # 43028A)	43028-0020	1
PACKING,INTAKE MANIFOLD (Ref # 43049)	43049-0038	1
MANIFOLD-INTAKE (Ref # 59076)	59076-0014	1
RING-O (Ref # 92055)	92055-0856	1
SPRING (Ref # 92145)	92145-1712	1
BOLT,FLANGED,6X20 (Ref # 92154)	92154-1988	1
BOLT,FLANGED,6X75 (Ref # 92154A)	92154-1989	1
SCREW,5X10 (Ref # 92172)	92172-0985	1
SCREW,5X16 (Ref # 92172A)	92172-0986	1