

2020 MULE PRO-DXT™ DIESEL PARTS DIAGRAM

Oil Pan/Oil Filter

E1711

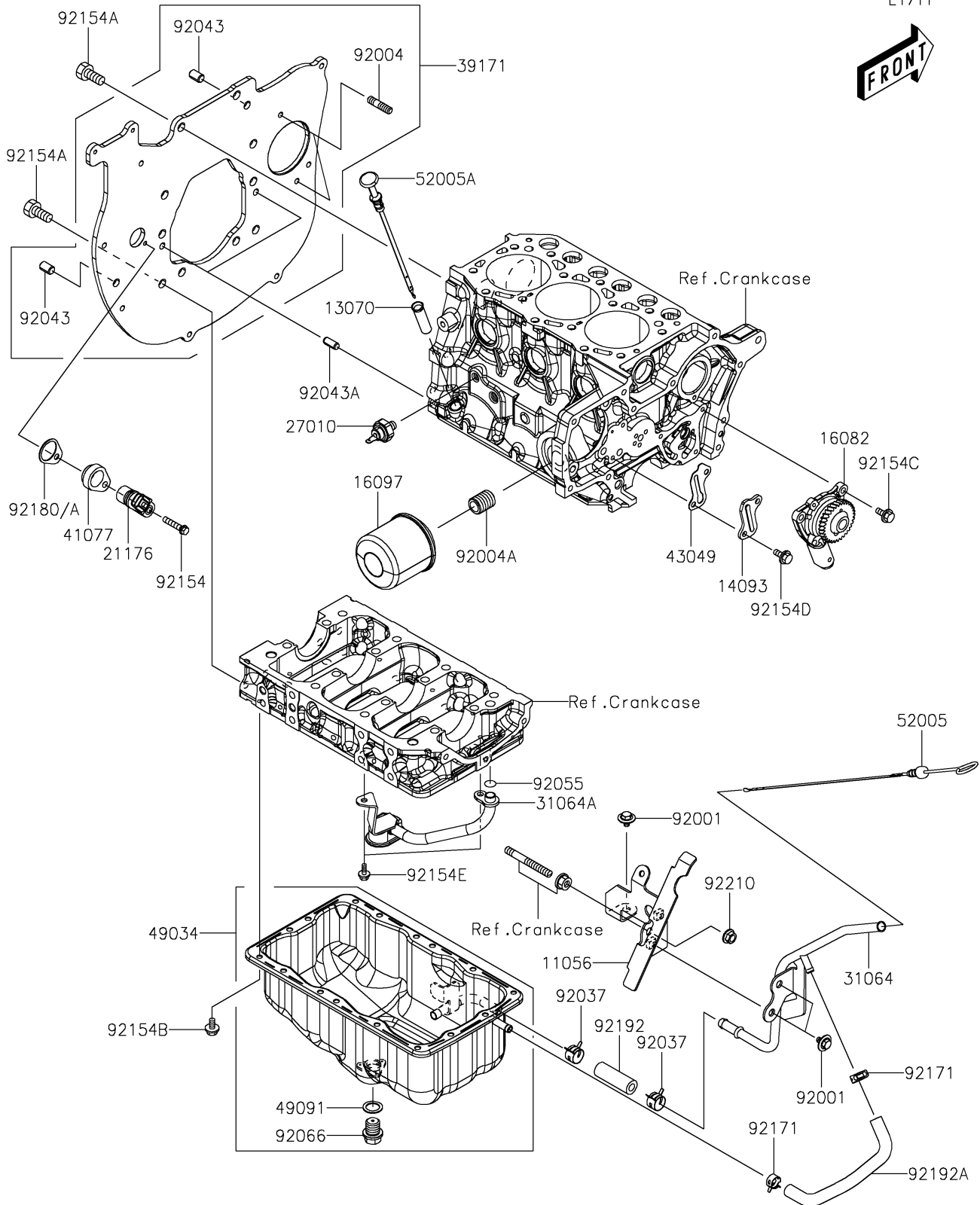

2020 MULE PRO-DXT™ DIESEL PARTS LIST

Oil Pan/Oil Filter

ITEM NAME	PART NUMBER	QUANTITY
BRACKET,LEVEL GAUGE PIPE (Ref # 11056)	11056-7693	1
GUIDE,OIL LEVEL GAUGE (Ref # 13070)	13070-0830	1
COVER (Ref # 14093)	14093-0445	1
PUMP-ASSY-OIL (Ref # 16082)	16082-0763	1
FILTER-ASSY-OIL (Ref # 16097)	16097-0012	1
SENSOR,ROTATION (Ref # 21176)	21176-0767	1
SWITCH,OIL PRESSURE (Ref # 27010)	27010-0838	1
PIPE-COMP,LEVEL GAUGE (Ref # 31064)	31064-0677	1
PIPE-COMP,OIL (Ref # 31064A)	31064-0679	1
FLANGE-COMP (Ref # 39171)	39171-0003	1
ADAPTER,ROTATION SENSOR (Ref # 41077)	41077-0722	1
PACKING (Ref # 43049)	43049-0039	1
PAN-OIL (Ref # 49034)	49034-0566	1
WASHER-SEAL (Ref # 49091)	49091-0006	1
GAUGE,OIL LEVEL (Ref # 52005)	52005-0754	1
GAUGE,OIL LEVEL (Ref # 52005A)	52005-0759	1
BOLT,FLANGED,6X10 (Ref # 92001)	92001-1034	3
STUD,8X25 (Ref # 92004)	92004-0745	2
STUD (Ref # 92004A)	92004-0749	1
CLAMP (Ref # 92037)	92037-1678	2
PIN,10X16 (Ref # 92043)	92043-0885	2
PIN,8X16 (Ref # 92043A)	92043-0886	2
RING-O (Ref # 92055)	92055-0857	1
PLUG,DRAIN (Ref # 92066)	92066-0851	1
BOLT,FLANGED,6X30 (Ref # 92154)	92154-1857	1
BOLT,10X20 (Ref # 92154A)	92154-1985	9
BOLT,TORX,6X10 (Ref # 92154B)	92154-1986	16
BOLT,FLANGED,6X14 (Ref # 92154C)	92154-1997	3
BOLT,FLANGED,6X12 (Ref # 92154D)	92154-1998	2

2020 MULE PRO-DXT™ DIESEL PARTS LIST

Oil Pan/Oil Filter

ITEM NAME	PART NUMBER	QUANTITY
BOLT,FLANGED,6X10 (Ref # 92154E)	92154-2068	2
CLAMP,CLIP,12.5MM (Ref # 92171)	92171-0372	2
SHIM,T=1.0 (Ref # 92180)	92180-0968	AR
SHIM,T=0.5 (Ref # 92180A)	92180-0969	AR
TUBE,9X17.5X52 (Ref # 92192)	92192-1482	1
TUBE,PIPE COMP-OIL PAN (Ref # 92192A)	92192-1501	1
NUT,FLANGED,8MM (Ref # 92210)	92210-0555	1