

2020 KLX®150L PARTS DIAGRAM

Side Covers/Chain Cover

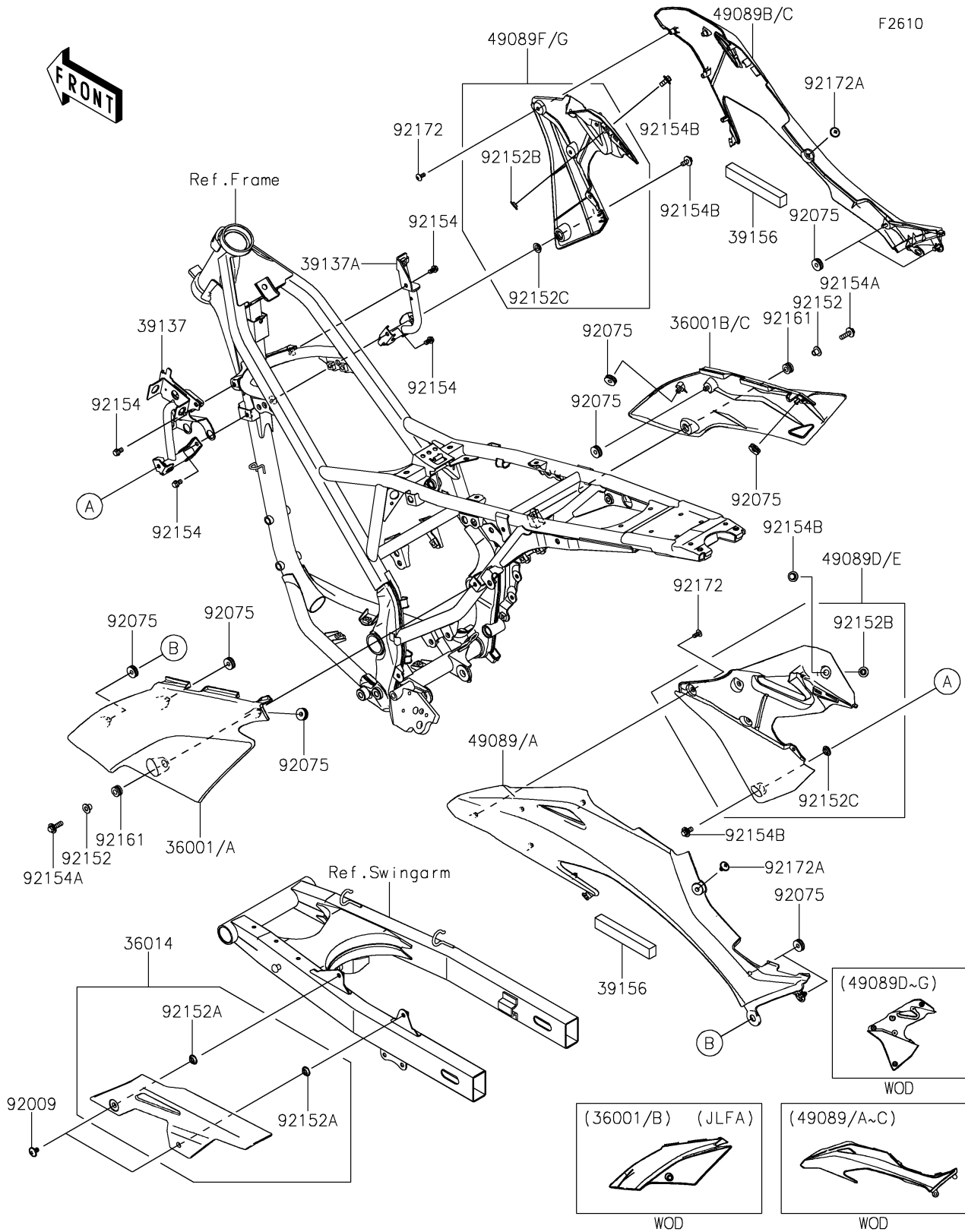

2020 KLX®150L PARTS LIST

Side Covers/Chain Cover

ITEM NAME	PART NUMBER	QUANTITY
-----------	-------------	----------