

2018 MULE SX™ PARTS DIAGRAM

Wheels/Tires

F2210

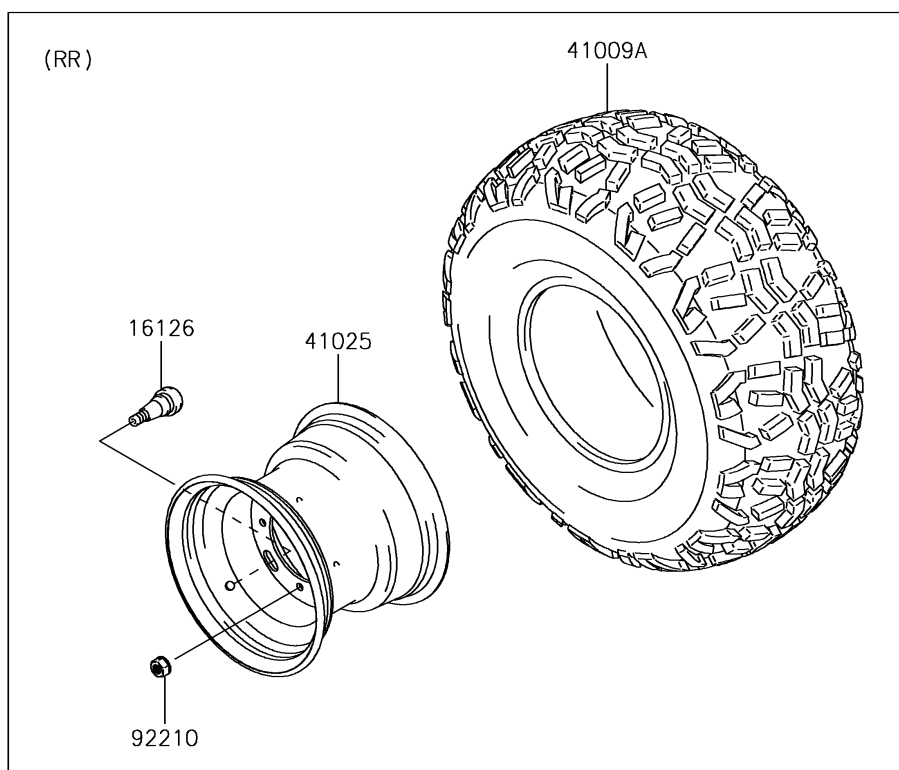
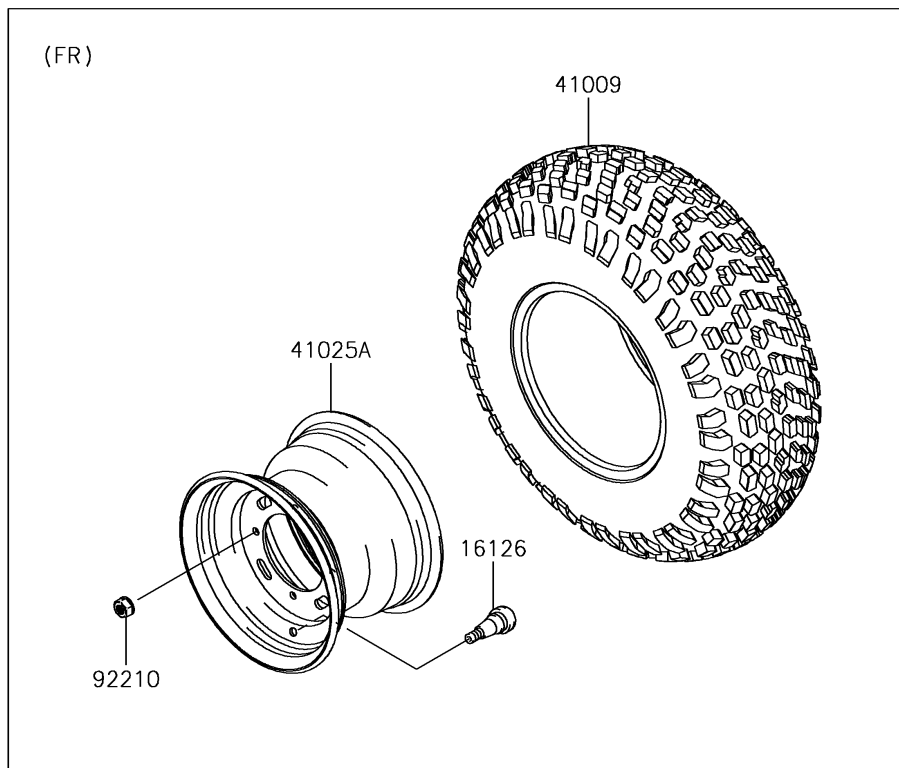

2018 MULE SX™ PARTS LIST

Wheels/Tires

ITEM NAME	PART NUMBER	QUANTITY
VALVE (Ref # 16126)	16126-4001	1
TIRE,FR,22X9.00-10 4PR,DI-K109 (Ref # 41009)	41009-0767	1
TIRE,RR,22X11.00-10,K968 (Ref # 41009A)	41009-0768	1
RIM,RR,10X8.5,F.S.BLACK (Ref # 41025)	41025-0039-397	1
RIM,FR,10X7.0 AT,F.S.BLACK (Ref # 41025A)	41025-0040-397	1
NUT,LOCK,10MM (Ref # 92210)	92210-1204	1