

2007 Brute Force 650 4x4 Hardwoods Green HD PARTS DIAGRAM

Air Cleaner

E1130

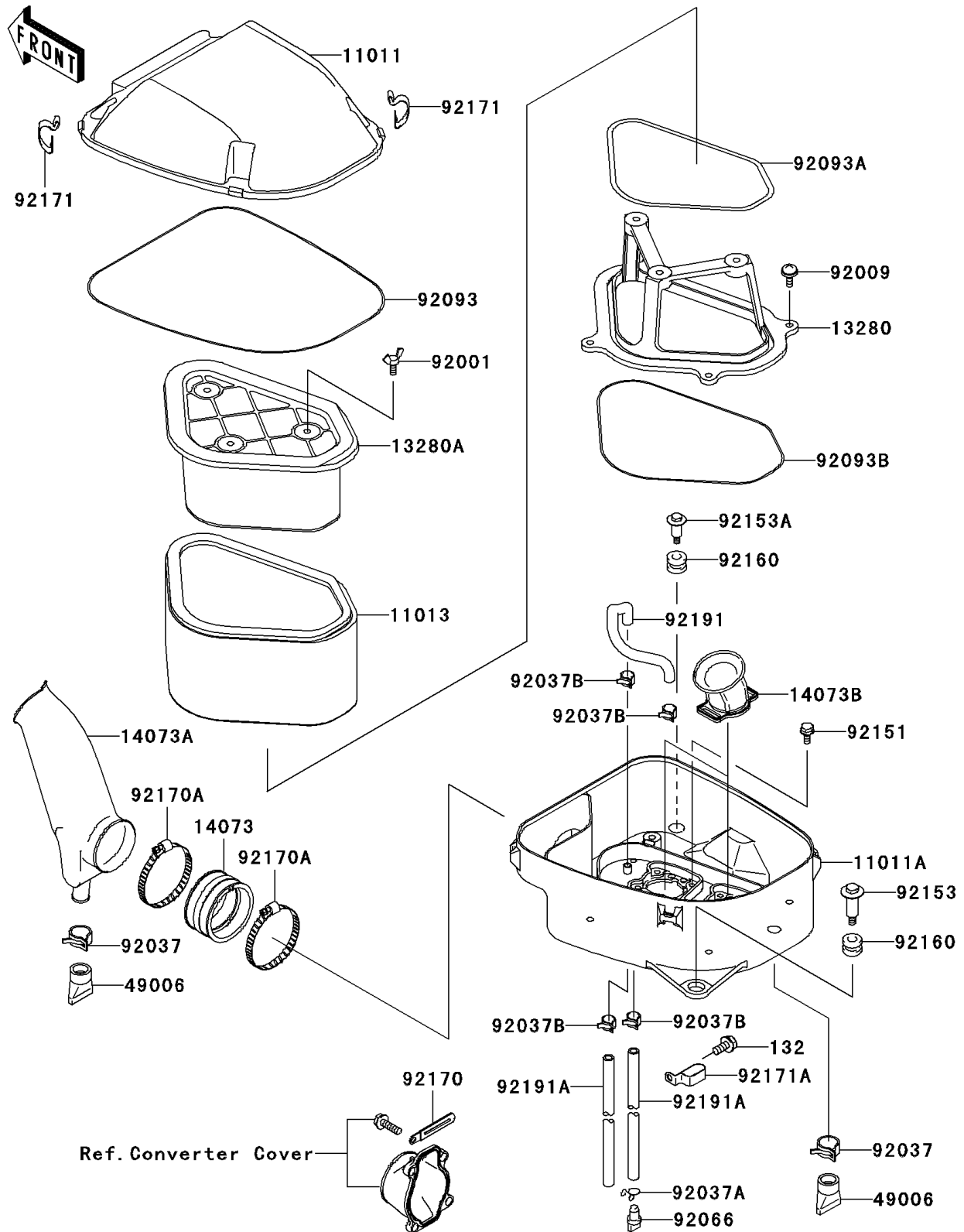

2007 Brute Force 650 4x4 Hardwoods Green HD PARTS LIST

Air Cleaner

ITEM NAME	PART NUMBER	QUANTITY
BOLT-FLANGED-SMALL,6X12 (Ref # 132)	132BD0612	1
CASE-AIR FILTER,UPP (Ref # 11011)	11011-0046	1
CASE-AIR FILTER,LWR (Ref # 11011A)	11011-0047	1
ELEMENT-AIR FILTER (Ref # 11013)	11013-0001	1
HOLDER (Ref # 13280)	13280-0111	1
HOLDER (Ref # 13280A)	13280-1272	1
DUCT,JOINT (Ref # 14073)	14073-1775	1
DUCT,INTAKE (Ref # 14073A)	14073-1778	1
DUCT,AIR FANNEL (Ref # 14073B)	14073-1830	1
BOOT (Ref # 49006)	49006-1292	1
BOLT,WING,6X15 (Ref # 92001)	92001-1703	1
SCREW,6X16 (Ref # 92009)	92009-1621	1
CLAMP,HOSE CLIP (Ref # 92037)	92037-1460	1
CLAMP,TUBE (Ref # 92037A)	92037-147	1
CLAMP,TUBE (Ref # 92037B)	92037-1505	1
PLUG,DRAIN (Ref # 92066)	92066-1211	1
SEAL,AIR FILTER CASE (Ref # 92093)	92093-1522	1
SEAL,HOLDER-HOLDER (Ref # 92093A)	92093-1569	1
SEAL (Ref # 92093B)	92093-1570	1
BOLT,FLANGED,5X12 (Ref # 92151)	92151-1305	1
BOLT,AIR FILTER,LH (Ref # 92153)	92153-1051	1
BOLT,FLANGED,6X28.7 (Ref # 92153A)	92153-1052	1
DAMPER (Ref # 92160)	92160-1594	1
CLAMP (Ref # 92170)	92170-1514	1
CLAMP (Ref # 92170A)	92170-1764	1
CLAMP,AIR FILTER CASE (Ref # 92171)	92171-1394	1
CLAMP,AIR VENT (Ref # 92171A)	92171-1522	1
TUBE,7X11X210 (Ref # 92191)	92191-1494	1
TUBE,7X11X470 (Ref # 92191A)	92191-1531	1