

2020 KLX®140L PARTS DIAGRAM

Front Master Cylinder

F2291

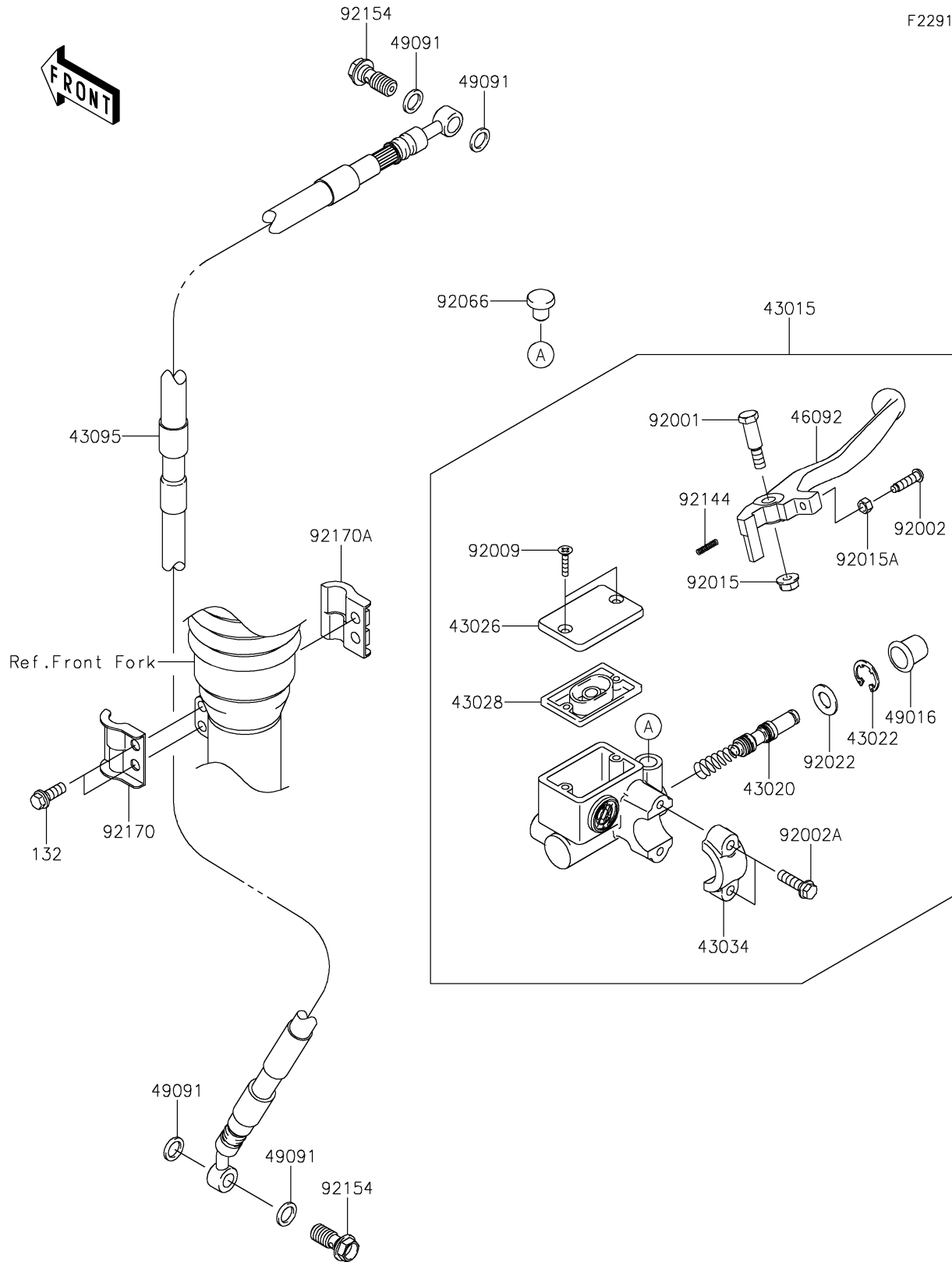

2020 KLX®140L PARTS LIST

Front Master Cylinder

ITEM NAME	PART NUMBER	QUANTITY
BOLT-FLANGED-SMALL,6X16 (Ref # 132)	132BA0616	1
CYLINDER-ASSY-MASTER,FR (Ref # 43015)	43015-0106	1
PISTON-COMP-BRAKE (Ref # 43020)	43020-1065	1
STOPPER-BRAKE,PISTON (Ref # 43022)	43022-1010	1
CAP-BRAKE (Ref # 43026)	43026-1074	1
DIAPHRAGM (Ref # 43028)	43028-1061	1
HOLDER-BRAKE,MASTER CYLINDER (Ref # 43034)	43034-1016	1
HOSE-BRAKE,FR (Ref # 43095)	43095-0335	1
LEVER-GRIP,FRONT BRAKE (Ref # 46092)	46092-1175	1
COVER-SEAL,MASTER CYLINDER (Ref # 49016)	49016-1044	1
WASHER-SEAL,10.1X14.5X1.5 (Ref # 49091)	49091-0001	1
BOLT,FRONT BRAKE LEVER (Ref # 92001)	92001-1728	1
BOLT,ADJUST (Ref # 92002)	92002-1893	1
BOLT (Ref # 92002A)	92002-1894	1
SCREW,4MM (Ref # 92009)	92009-1458	1
NUT,FLANGED,6MM,BLACK (Ref # 92015)	92015-1233	1
NUT,ADJUST (Ref # 92015A)	92015-1642	1
WASHER (Ref # 92022)	92022-1814	1
PLUG (Ref # 92066)	92066-1348	1
SPRING,RETURN (Ref # 92144)	92144-1103	1
BOLT,OIL,L=23 (Ref # 92154)	92154-0226	1
CLAMP,BRAKE HOSE,OUTSIDE (Ref # 92170)	92170-1231	1
CLAMP,BRAKE HOSE,INSIDE (Ref # 92170A)	92170-1232	1