

2016 KX™85 PARTS DIAGRAM

Accessory

F2910

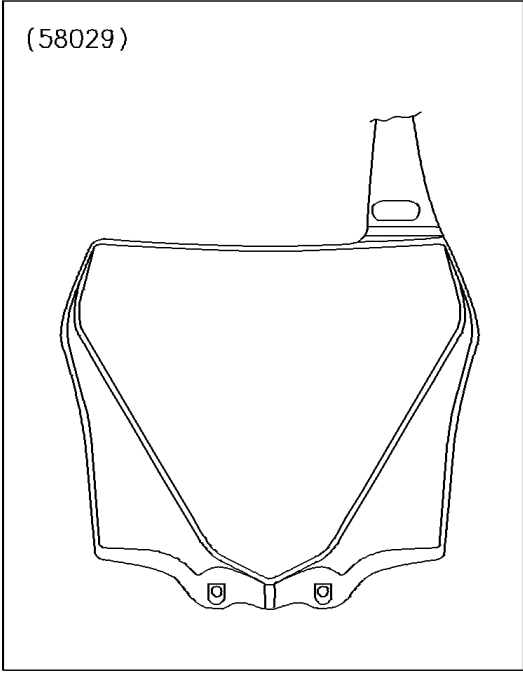
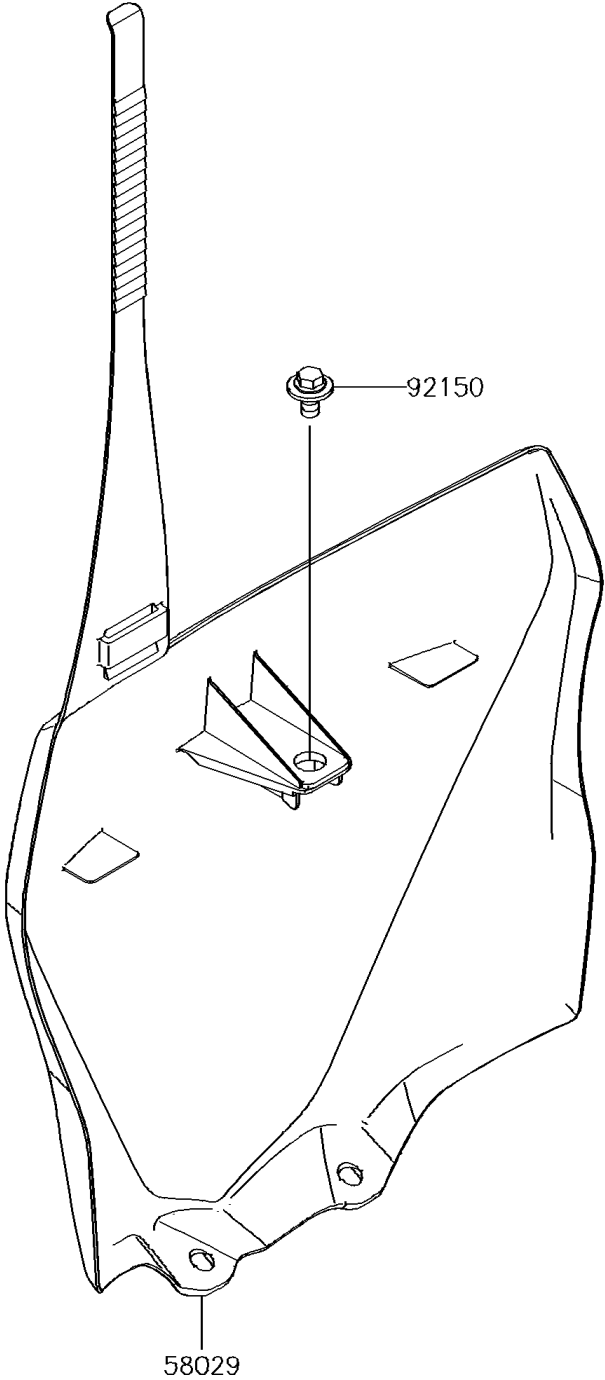

2016 KX™85 PARTS LIST

Accessory

ITEM NAME	PART NUMBER	QUANTITY
PLATE-NUMBER,B.WHITE (Ref # 58029)	58029-0011-266	1
BOLT,6X12 (Ref # 92150)	92150-1435	1