

2017 KX™85 PARTS DIAGRAM

Swingarm

F2141

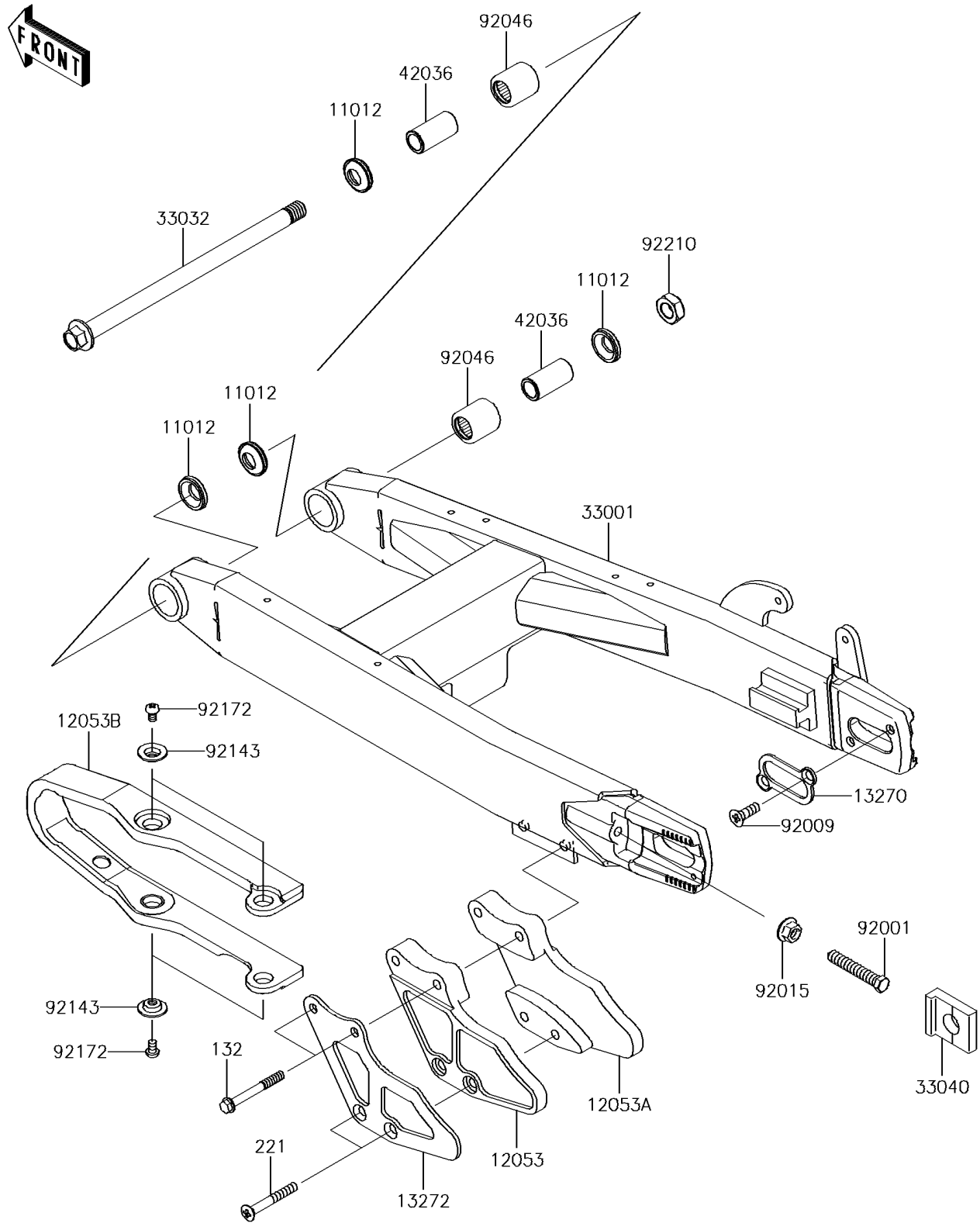

2017 KX™85 PARTS LIST

Swingarm

ITEM NAME	PART NUMBER	QUANTITY
CAP (Ref # 11012)	11012-1263	1
GUIDE-CHAIN,RR,LH (Ref # 12053)	12053-0209	1
GUIDE-CHAIN,RR,RH (Ref # 12053A)	12053-0210	1
GUIDE-CHAIN,FR (Ref # 12053B)	12053-1414	1
BOLT-FLANGED-SMALL,6X50 (Ref # 132)	132BA0650	1
PLATE (Ref # 13270)	13270-1899	1
PLATE,GUIDE CHAIN (Ref # 13272)	13272-1446	1
SCREW-CSK-CROS,6X45 (Ref # 221)	221AA0645	1
ARM-COMP-SWING (Ref # 33001)	33001-0610	1
SHAFT-SWING ARM (Ref # 33032)	33032-1161	1
ADJUSTER-CHAIN (Ref # 33040)	33040-0039	1
SLEEVE,SWING ARM,L=34 (Ref # 42036)	42036-1067	1
BOLT,8X46 (Ref # 92001)	92001-1179	1
SCREW,5X10 (Ref # 92009)	92009-1828	1
NUT,FLANGED,8MM (Ref # 92015)	92015-1014	1
BEARING-NEEDLE (Ref # 92046)	92046-1046	1
COLLAR (Ref # 92143)	92143-1676	1
SCREW,5X8 (Ref # 92172)	92172-0119	1
NUT,LOCK,12MM (Ref # 92210)	92210-1249	1