

2019 KLX® 250 CAMO PARTS DIAGRAM

Cylinder Head

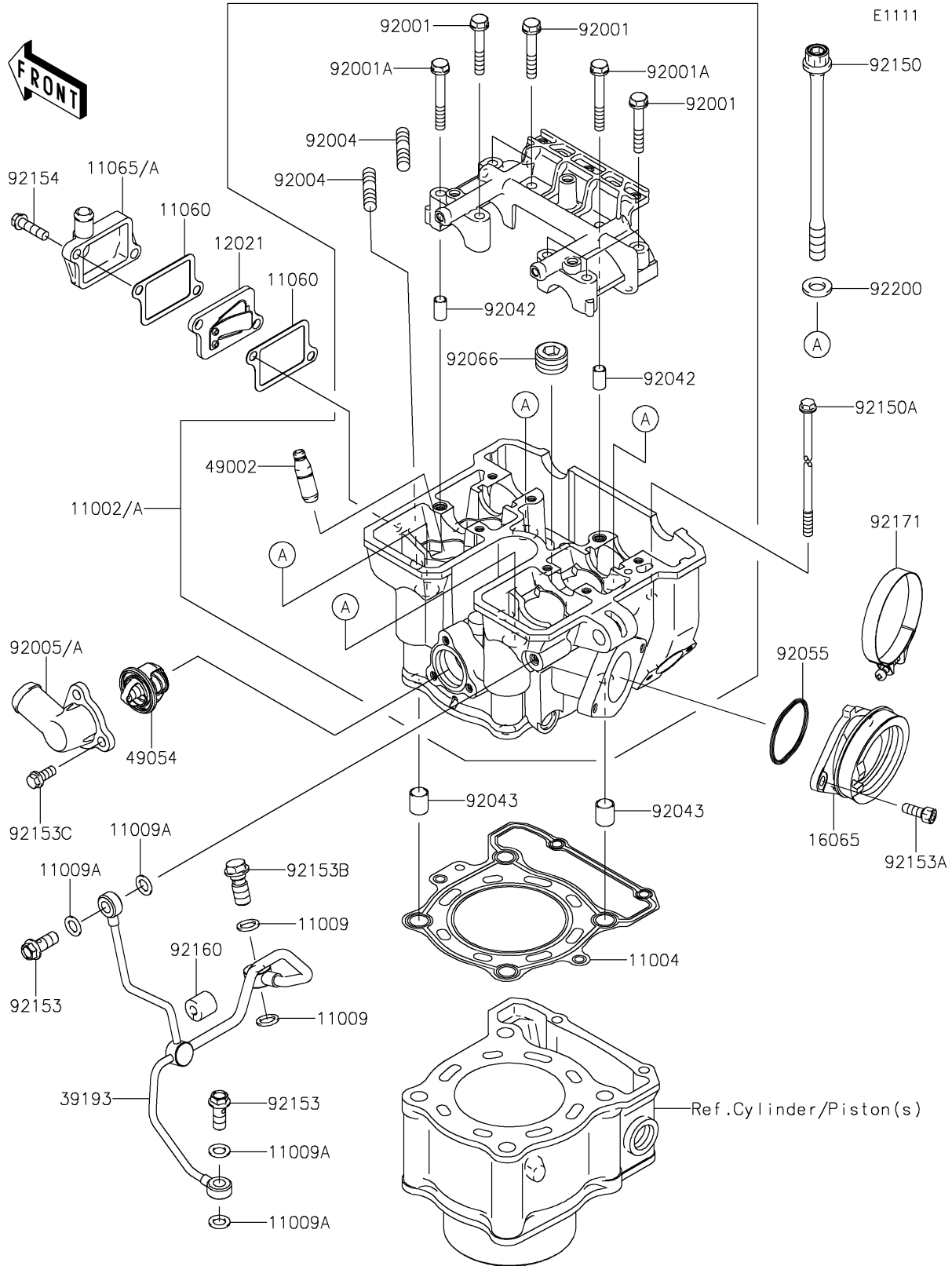

2019 KLX®250 CAMO PARTS LIST

Cylinder Head

ITEM NAME	PART NUMBER	QUANTITY
HEAD-ASSY-CYLINDER (Ref # 11002A)	11002-0074	1
GASKET-HEAD (Ref # 11004)	11004-1249	1
GASKET,10X14.5X1.5 (Ref # 11009)	11009-1105	1
GASKET,8.2X14X1.0 (Ref # 11009A)	11009-1344	1
GASKET,AIR SUCTION VALVE (Ref # 11060)	11060-1886	1
CAP (Ref # 11065A)	11065-0341	1
VALVE-ASSY-REED (Ref # 12021)	12021-1115	1
HOLDER-CARBURETOR (Ref # 16065)	16065-0045	1
PIPE-OIL (Ref # 39193)	39193-0045	1
GUIDE-VALVE (Ref # 49002)	49002-1126	1
THERMOSTAT (Ref # 49054)	49054-1053	1
BOLT,FLANGED,6X38 (Ref # 92001)	92001-1105	1
BOLT,6X46 (Ref # 92001A)	92001-1872	1
STUD (Ref # 92004)	92004-0050	1
FITTING (Ref # 92005A)	92005-0778	1
PIN,DOWEL,6.3X8X14 (Ref # 92042)	92042-007	1
PIN,10.1X12X14 (Ref # 92043)	92043-4009	1
RING-O (Ref # 92055)	92055-1255	1
PLUG,PT1/2X12.5 (Ref # 92066)	92066-0002	1
BOLT,10X165 (Ref # 92150)	92150-1368	1
BOLT,6X135 (Ref # 92150A)	92150-1552	1
BOLT,BANJO,8X20 (Ref # 92153)	92153-0651	1
BOLT,SOCKET,6X16 (Ref # 92153A)	92153-1344	1
BOLT,BANJO,10X23 (Ref # 92153B)	92153-1345	1
BOLT (Ref # 92153C)	92153-1805	1
BOLT,FLANGED,6X22 (Ref # 92154)	92154-0504	1
DAMPER,6.3X15X14 (Ref # 92160)	92160-1523	1
CLAMP (Ref # 92171)	92171-0643	1
WASHER,10.5X19X2.3 (Ref # 92200)	92200-1042	1