

2019 W175 SE (Indonesia Only) PARTS DIAGRAM

Crankcase

E1411

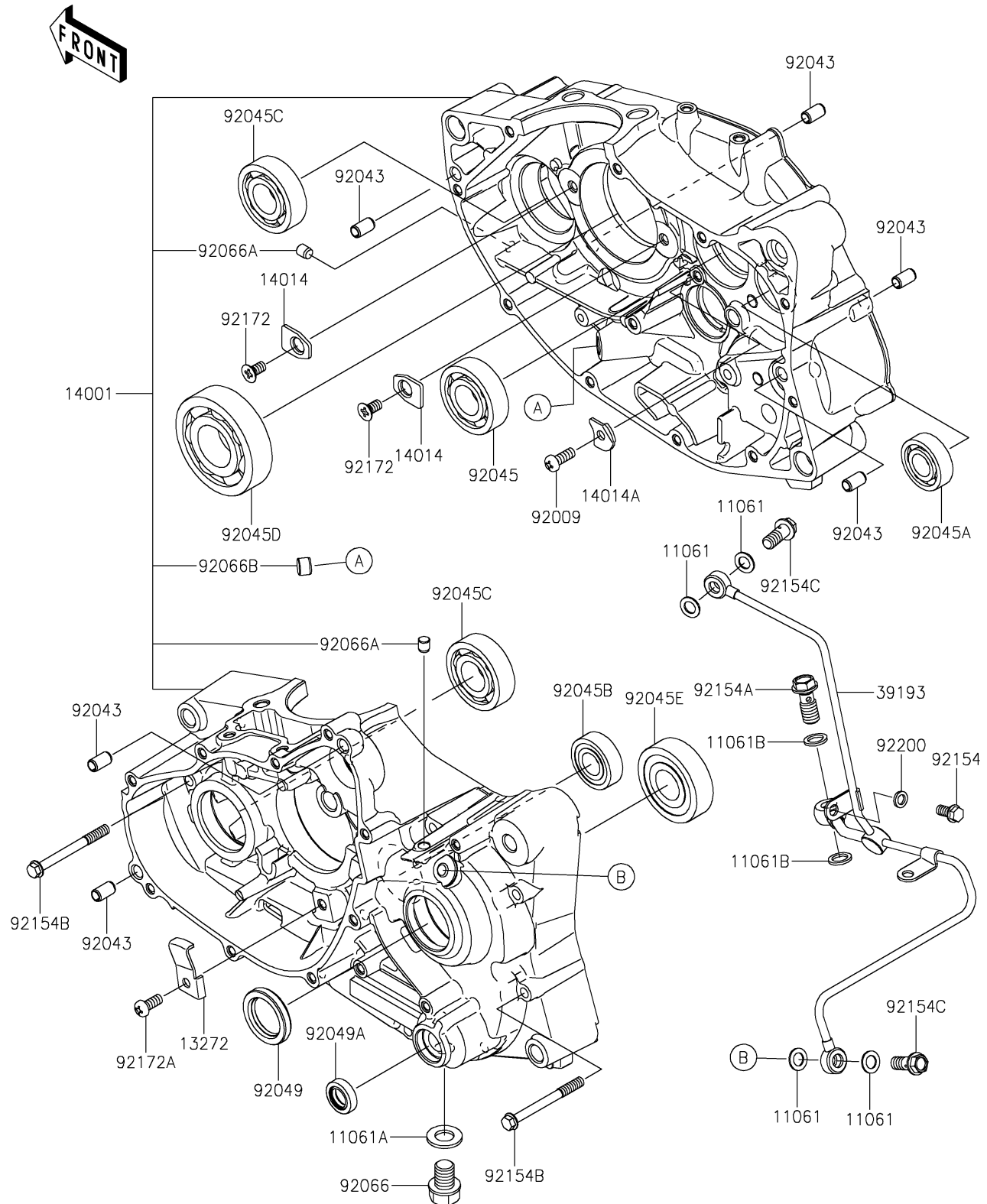

2019 W175 SE (Indonesia Only) PARTS LIST

Crankcase

ITEM NAME	PART NUMBER	QUANTITY
GASKET,8.2X13.8X1 (Ref # 11061)	11061-1243	1
GASKET,12X22X2 (Ref # 11061A)	11061-1244	1
GASKET,10X14.5X1.5 (Ref # 11061B)	11061-1254	1
PLATE (Ref # 13272)	13272-1342	1
SET-CRANKCASE (Ref # 14001)	14001-0683	1
PLATE-POSITION (Ref # 14014)	14014-0048	1
PLATE-POSITION,DRUM (Ref # 14014A)	14014-1113	1
PIPE-OIL (Ref # 39193)	39193-0584	1
SCREW-PAN-CROS,6X16 (Ref # 92009)	92009-1266	1
PIN,6.2X8X14 (Ref # 92043)	92043-1263	1
BEARING-BALL,20X47X14 (Ref # 92045)	92045-0832	1
BEARING-BALL,15X35X11 (Ref # 92045A)	92045-0833	1
BEARING-BALL,15X35X11 (Ref # 92045B)	92045-0834	1
BEARING-BALL,20X47X14 (Ref # 92045C)	92045-0836	1
BEARING-BALL,28X68X18 (Ref # 92045D)	92045-0837	1
BEARING-BALL,20X52X15 (Ref # 92045E)	92045-0843	1
SEAL-OIL (Ref # 92049)	92049-0757	1
SEAL-OIL (Ref # 92049A)	92049-1559	1
PLUG,OIL DRAIN,12X15 (Ref # 92066)	92066-0768	1
PLUG,OIL LINE,7.2X8 (Ref # 92066A)	92066-1012	1
PLUG,10.5MM (Ref # 92066B)	92066-1355	1
BOLT,FLANGED,6X12 (Ref # 92154)	92154-2753	1
BOLT,BANJO,10X23 (Ref # 92154A)	92154-2761	1
BOLT,FLANGED,6X60 (Ref # 92154B)	92154-2762	1
BOLT,FLANGED,8X20 (Ref # 92154C)	92154-3754	1
SCREW,6X12 (Ref # 92172)	92172-1200	1
SCREW,6X14 (Ref # 92172A)	92172-1201	1
WASHER,6.3X10.2X1.6 (Ref # 92200)	92200-1982	1